



Cabinet Knob & Pull Collections

— 2024 —

The Finishing Touch That Makes A Statement

Alvar.....	2-3	Lyon.....	39	Aiden.....	84-85
Annadale.....	4	Marie.....	48	Asher.....	83
Anwick.....	5	Marlo.....	49	Belfast.....	86
Audrey.....	6-7	Merrick.....	50-51	Brenton.....	87
Belcastel 1.....	8-9	Milan 1.....	52-53	Cosgrove.....	88
Boswell.....	10-11	Mirada.....	54	Edgefield NEW FINISH	90-91
Bremen 1.....	12-13	Philip.....	56-57	Florence.....	89
Bremen 2.....	14	Regan.....	55	Gibson NEW SIZES	92-93
Cairo.....	15	Renzo.....	58-59	Glendale.....	96
Callie.....	16-17	Richard.....	60-61	Hadly.....	94-95
Carmen.....	18-19	Roman.....	62-63	Kenner.....	97
Cordova.....	20	Royce.....	64	Knox.....	98-99
Delgado.....	21	Sonoma.....	65	Madison.....	100
Delmar.....	22	Southerland NEW	66-67	Naples.....	102-105
Dominique.....	24-25	Spencer.....	68-69	Park.....	101
Durham.....	23	Sullivan.....	70-71	Seaver.....	106
Elara.....	26-27	Sutton.....	72-73	Sedona.....	107
Ella.....	28	Tahoe.....	76	Slade.....	108
Harlow.....	29	Tiffany.....	74-75	Somerset.....	109
Hayworth.....	30-31	Wheeler.....	77	Stanton.....	110-111
Hudson.....	32	Whitlock NEW	78-79	Strickland.....	112
Katharine.....	33	Zane.....	80-81	Thatcher.....	114-115
Key Grande.....	34-35			Torino.....	113
Key West & Key Largo.....	36-37			Walker 1 & 2.....	116-117
Lafayette.....	38			William NEW	118-119
Larkin 1 & 2.....	40,42			Watervale.....	120
Larkin 3 & 4 NEW	41,43			Zachary.....	121
Leyton.....	44-45				
Loxley NEW	46-47				

Each Jeffrey Alexander and Elements item in this catalog has been marked with a letter code. The letter by each item corresponds to a price range for that item's suggested retail price. For the exact price on any item, please visit www.HardwareResources.com

Projection	Inner Box	Price Code
1-1/16"	20	[D]
1-1/16"	20	[E]
1-1/16"	20	[E]
1-1/16"	10	[F]
1-1/16"	10	[G]

Label	Price Range
[A]	Under \$3.50
[B]	~\$3.50 – \$5.00
[C]	~\$5.00 – \$6.00
[D]	~\$6.00 – \$8.50
[E]	~\$8.50 – \$10.75
[F]	~\$10.75 – \$14.50
[G]	~\$14.50 – \$18.00
[H]	~\$18.00 – \$23.75
[J]	~\$23.75 – \$31.00
[K]	See Sales Associate

Price range subject to change. Please contact your sales representative to ensure you have the most recent price range.



This catalog features a selection of our Jeffrey Alexander and Elements knob and pull collections. Please visit www.JeffreyAlexander.com for our complete offering.



A step above...in Quality, Selection, & Design

Quality

All our products are manufactured from the highest quality materials and undergo meticulous examination to ensure only the best products reach your door. We believe strongly in the quality, integrity, and reliability of our products and offer a lifetime warranty on all Jeffrey Alexander decorative hardware.

Selection

Jeffrey Alexander offers 60+ patented and original collections plus a variety of industry-standard designs in a wide range of styles and finishes. With extended lengths as well as appliance handles available in many of our collections, there's something for everyone.

Designs

Inspiration comes from the latest styles in interior design to the newest fashion trends on the runway. That inspiration is creatively transformed into beautiful hardware for any kitchen, bath, or home project. Our designs are heavier in weight with solid or flat backs, not hollow backs, adding a touch of luxury while providing a comfortable feel in your hand.



GRACEFUL

Alvar's graceful yet straightforward and contemporary curved profile is sure to enchant. With a variety of lengths and finishes, this pull collection blends well with raised panel, flat panel, and Shaker-style cabinets.



Shown in Brushed Pewter



Pulls	Center-to-Center	Overall Length	Foot Width x Length	Projection	Inner Box	Price Code
264-3	3" CC	3-11/16"	3/8" x 5/8"	1-1/16"	20	[D]
264-96	96 mm (3-3/4") CC	4-7/16"	3/8" x 5/8"	1-1/16"	20	[E]
264-128	128 mm (5-1/16") CC	5-3/4"	3/8" x 5/8"	1-1/16"	20	[E]
264-160	160 mm (6-5/16") CC	7"	3/8" x 5/8"	1-1/16"	10	[F]
264-192	192 mm (7-9/16") CC	8-1/4"	3/8" x 5/8"	1-1/16"	10	[G]

Finishes



BNBDL
Brushed Pewter



DBAC
Brushed Oil
Rubbed Bronze



MB
Matte Black



NI
Polished Nickel



PC
Polished Chrome



SBZ
Satin Bronze



SN
Satin Nickel

Annadale

JEFFREY ALEXANDER®
by Hardware Resources

US Patent #
D708,040; D708,926; D721,941; D711,722



Knobs	Description	Overall Length	Foot		Inner Box	Price Code
			Width x Length	Projection		
435	square knob	1-1/4"	3/4" x 3/4"	1-1/4"	20	[F]
435L	rectangle knob	1-1/2"	3/4" x 3/4"	1-1/4"	20	[F]

Pulls	Center-to-Center	Overall Length	Foot		Inner Box	Price Code
			Width x Length	Projection		
435-96	96 mm (3-3/4") CC	5"	1-1/4" x 1"	1-1/8"	10	[G]
436-96	96 mm (3-3/4") CC cup pull	5"	1-1/4" x 5"	1-1/8"	10	[H]
435-128	128 mm (5-1/16") CC	6-1/4"	1-1/4" x 1"	1-3/16"	10	[J]
436-128	128 mm (5-1/16") CC cup pull	6-1/4"	1-1/4" x 6-1/4"	1-3/16"	10	[K]
435-160	160 mm (6-5/16") CC	7-9/16"	1-1/4" x 1"	1-3/16"	10	[K]

Finishes





Knobs	Description	Overall Length	Foot Width x Length	Projection	Inner Box	Price Code
867	rectangle knob	1-3/8"	5/8" x 5/16"	1-1/16"	30	[E]
867L	square knob	1-1/8"	1-1/8" x 5/16"	1-1/16"	20	[E]

Pulls	Center-to-Center	Overall Length	Foot Width x Length	Projection	Inner Box	Price Code
867-3	3" CC	4-5/16"	5/8" x 5/16"	1-1/16"	10	[F]
867-96	96 mm (3-3/4") CC	5-1/8"	5/8" x 5/16"	1-1/16"	10	[G]
867-128	128 mm (5-1/16") CC	6-3/8"	5/8" x 5/16"	1-1/16"	10	[H]
867-160	160 mm (6-5/16") CC	7-5/8"	5/8" x 5/16"	1-1/16"	10	[J]
867-228	228 mm (9") CC	10-5/16"	5/8" x 5/16"	1-1/16"	10	[K]
867-320	320 mm (12-5/8") CC	13-15/16"	5/8" x 5/16"	1-1/16"	10	[K]

Finishes



BNBDL
Brushed Pewter



DBAC
Brushed Oil
Rubbed Bronze



NI
Polished Nickel



SN
Satin Nickel

Audrey

US Patent #
D989,600; D996,183



Knobs	Description	Overall Length	Foot		Inner Box	Price Code
			Width x Length	Projection		
278	square knob	1-1/8"	1/2" x 1/2"	1-7/16"	20	[D]
278L	large square knob	1-3/8"	1/2" x 1/2"	1-7/16"	10	[D]

Pulls	Center-to-Center	Overall Length	Foot		Inner Box	Price Code
			Width x Length	Projection		
278-96	96 mm (3-3/4") CC	4-1/4"	1/2" x 1/2"	1-1/2"	10	[E]
278-128	128 mm (5-1/16") CC	5-9/16"	1/2" x 1/2"	1-1/2"	10	[F]
278-160	160 mm (6-5/16") CC	6-13/16"	1/2" x 1/2"	1-1/2"	10	[G]
278-192	192 mm (7-9/16") CC	8-1/16"	1/2" x 1/2"	1-1/2"	10	[H]
278-224	224 mm (8-3/16") CC	9-3/8"	9/16" x 9/16"	1-9/16"	10	[H]
278-305	305 mm (12") CC	12-9/16"	9/16" x 9/16"	1-9/16"	10	[K]
278-12	12" CC appl. handle	12-5/8"	3/4" x 3/4"	2-1/4"	5	[K]
278-18	18" CC appl. handle	18-3/4"	3/4" x 3/4"	2-1/4"	5	[K]

JEFFREY ALEXANDER®

by Hardware Resources



Shown in Satin Bronze

POISED

Poised and effortlessly charming, Audrey from Jeffrey Alexander adds understated elegance to any room. With an impeccably tailored silhouette on both the cabinet knob and pull, this collection delivers a modern expression with lavish contours, sparkling with charisma and class. The sweeping curves of Audrey's cabinet pull not only provide an exceptional feel in the hand but also add a little more hand clearance for ensured comfortability.

Finishes



BG
Brushed
Gold



BNBDL
Brushed
Pewter



DBAC
Brushed Oil
Rubbed Bronze



MB
Matte Black



PC
Polished
Chrome



SBZ
Satin Bronze



SN
Satin Nickel



CLASSIC

Belcastel 1 embodies a classic and dashing personality with its soft, square foot and gentle curves. This collection is a chameleon, harmoniously melding with Shaker, traditional, or slab cabinet styles with its eleven different finishes.



Shown in Satin Nickel

Finishes



ABM-D
Distressed
Antique Brass



BNBDL
Brushed
Pewter



DACM
Gun Metal



DBAC
Brushed Oil
Rubbed Bronze



DMAC
Distressed Oil
Rubbed Bronze



MB
Matte Black



NI
Polished
Nickel



PC
Polished
Chrome



SBZ
Satin Bronze



SIM-D
Distressed
Antique Silver



SN
Satin Nickel

Belcastel 1



Knobs	Description	Overall Length	Foot Width x Length	Projection	Inner Box	Price Code
MO6303	round knob	1-3/8"	11/16" x 13/16"	1-1/16"	20	[D]

Pulls	Center-to-Center	Overall Length	Foot Width x Length	Projection	Inner Box	Price Code
MO6373	96 mm (3-3/4") CC	4-5/8"	3/4" x 7/8"	1-3/16"	15	[E]
MO6373-128	128 mm (5-1/16") CC	5-7/8"	3/4" x 7/8"	1-3/16"	20	[F]
MO6373-160	160 mm (6-5/16") CC	7-1/8"	3/4" x 7/8"	1-3/16"	10	[G]
MO6373-12	12" CC appl. handle	13-1/4"	1-1/8" x 1-1/4"	2-5/16"	5	[K]
MO6373-18	18" CC appl. handle	19-1/4"	1-1/8" x 1-1/4"	2-5/16"	5	[K]



Shown in Matte Black

CONTEMPORARY

Boswell combines gentle lines and a gracefully angled foot putting a modern twist on the traditional square bar pull. Adding a rounded undercurve for a touch of delicacy to the overall sleek profile, this pull collection is ideally suited to today's top trending soft contemporary styles.



Pulls	Center-to-Center	Overall Length	Foot Width x Length	Projection	Inner Box	Price Code
177-96	96 mm (3-3/4") CC	4-1/4"	1/2" x 5/8"	1-1/16"	15	[E]
177-128	128 mm (5-1/16") CC	5-9/16"	1/2" x 5/8"	1-1/16"	15	[F]
177-160	160 mm (6-5/16") CC	6-13/16"	1/2" x 5/8"	1-1/16"	10	[G]
177-192	192 mm (7-9/16") CC	8-1/16"	1/2" x 5/8"	1-1/16"	10	[G]
177-224	224 mm (8-13/16") CC	9-5/16"	1/2" x 5/8"	1-1/16"	10	[H]

Finishes



BNBDL
Brushed Pewter



DBAC
Brushed Oil
Rubbed Bronze



MB
Matte Black



PC
Polished Chrome



SN
Satin Nickel

Bremen 1



Knobs	Description	Overall Length	Foot Width x Length	Projection	Inner Box	Price Code
117	round knob	1-1/4"	3/4" x 3/4"	1-1/16"	20	[D]

Pulls	Center-to-Center	Overall Length	Foot Width x Length	Projection	Inner Box	Price Code
527	96 mm (3-3/4") CC	4-5/8"	7/8" x 7/8"	1-3/16"	15	[F]
527-128	128 mm (5-1/16") CC	5-7/8"	13/16" x 13/16"	1-1/8"	10	[F]
527-160	160 mm (6-5/16") CC	7-1/8"	13/16" x 13/16"	1-1/8"	10	[H]
527-12	12" CC appl. handle	13-1/8"	1-1/8" x 1-1/8"	2-1/16"	5	[K]



Shown in Satin Bronze

EFFORTLESS

The stylish curves and simple stacked feet of Bremen 1 deliver effortless appeal and pizzazz to cabinets. Mirroring those appealing qualities in its button knob, this collection is equally at home in transitional or traditional settings.

Finishes



ABM-D
Distressed
Antique Brass



ABSB
Antique Brushed
Satin Brass



BNBDL
Brushed
Pewter



DACM
Gun Metal



DBAC
Brushed Oil
Rubbed Bronze



DMAC
Distressed Oil
Rubbed Bronze



NI
Polished
Nickel



PC
Polished
Chrome



SBZ
Satin Bronze



SIM
Distressed
Antique Silver



SN
Satin
Nickel



Knobs	Description	Overall Length	Foot		Inner Box	Price Code
			Width x Length	Projection		
127	barrel knob	1-3/16"	13/16" x 13/16"	1-1/8"	20	[D]
137	stacked knob	1-1/4"	3/4" x 3/4"	1-1/8"	30	[D]

Pulls	Center-to-Center	Overall Length	Foot		Inner Box	Price Code
			Width x Length	Projection		
537	96 mm (3-3/4") CC	4-3/16"	3/8" x 3/8"	1-1/4"	20	[E]
537-128	128 mm (5-1/16") CC	5-7/16"	3/8" x 3/8"	1-1/4"	10	[F]
537-160	160 mm (6-5/16") CC	6-11/16"	3/8" x 3/8"	1-1/4"	10	[F]
537-12	12" CC appl. handle	12-11/16"	11/16" x 11/16"	1-5/8"	5	[K]

Finishes



ABSB
Antique Brushed
Satin Brass



DACM
Gun Metal



DBAC
Brushed Oil
Rubbed Bronze



DMAC
Distressed Oil
Rubbed Bronze



NI
Polished Nickel



SN
Satin Nickel



Knobs	Description	Overall Length	Foot Width x Length	Projection	Inner Box	Price Code
595	pyramid knob	1-1/4"	5/8" x 5/8"	7/8"	20	[D]

Pulls	Center-to-Center	Overall Length	Foot Width x Length	Projection	Inner Box	Price Code
595-96	96 mm (3-3/4") CC	4-13/16"	1" x 11/16"	1-1/8"	20	[E]
595-128	128 mm (5-1/16") CC	6-1/16"	1" x 11/16"	1-1/8"	15	[E]

Finishes



BNBDL
Brushed Pewter

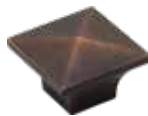

DBAC
Brushed Oil
Rubbed Bronze



PC
Polished Chrome



SN
Satin Nickel



Shown in Satin Bronze

SOPHISTICATED

Sophisticated and streamlined, Callie will enhance any modern or contemporary space. Pairing clean lines and subtle curves, this pull collection not only looks great but also feels great in your hand thanks to its rounded grip.

Callie

US Patent #
D790,315



Pulls	Center-to-Center	Overall Length	Foot Width x Length	Projection	Inner Box	Price Code
839-3	3" CC	4-3/16"	7/16" x 13/16"	1-1/4"	20	[E]
839-96	96 mm (3-3/4") CC	4-15/16"	7/16" x 13/16"	1-1/4"	15	[F]
839-128	128 mm (5-1/16") CC	6-1/4"	7/16" x 13/16"	1-1/4"	15	[G]
839-160	160 mm (6-5/16") CC	7-1/2"	7/16" x 13/16"	1-1/4"	10	[H]

Finishes



Carmen

US Patent #

D787,297; D787,296



Knobs	Description	Overall Length	Foot Width x Length	Projection	Inner Box	Price Code
775	round knob	1-1/8"	3/8" x 3/8"	1-7/16"	25	[F]
775L	T-knob	2"	3/8" x 3/8"	1-3/8"	25	[F]

Pulls	Center-to-Center	Overall Length	Foot Width x Length	Projection	Inner Box	Price Code
775-96	96 mm (3-3/4") CC	4-3/4"	3/8" x 3/8"	1-3/8"	10	[H]
775-128	128 mm (5-1/16") CC	6"	3/8" x 3/8"	1-3/8"	10	[J]
775-160	160 mm (6-5/16") CC	7-1/4"	3/8" x 3/8"	1-3/8"	10	[J]

Finishes



BG
Brushed Gold

MB
Matte Black

NI
Polished Nickel

PC
Polished Chrome

SBZ
Satin Bronze

SN
Satin Nickel



BRILLIANT

Bold, beautiful, and brilliant, Carmen is the perfect union of classic and contemporary. With its crystal-clear acrylic bar and industrial yet elegant stepped detail, this lustrous fusion evokes everlasting style with a modern-day twist.

Design Idea

Have fun and mix Carmen's beautiful acrylic with the solid options in Hayworth to instantly brighten any kitchen, bath, or closet. Find the Hayworth Collection on pages 30–31.



Shown in Brushed Gold

Cordova

JEFFREY ALEXANDER®
by Hardware Resources



Knobs	Description	Overall Length	Foot		Inner Box	Price Code
			Width x Length	Projection		
0251	flat top knob	1-3/8"	1-1/16" x 1-1/16"	1-1/16"	25	[C]
Z110	flared base knob	1-3/16"	3/4" x 3/4"	1-1/16"	30	[B]
Z111	button knob	1-1/4"	11/16" x 11/16"	1"	30	[C]

Pulls	Center-to-Center	Overall Length	Foot		Inner Box	Price Code
			Width x Length	Projection		
Z281	3" CC	3-3/8"	13/16" x 3/8"	1-1/4"	20	[D]
Z280	96 mm (3-3/4") CC	4-3/16"	13/16" x 3/8"	1-1/4"	20	[E]
Z281-128	128 mm (5-1/16") CC	5-7/16"	13/16" x 3/8"	1-5/16"	10	[F]
Z281-160	160 mm (6-5/16") CC	6-11/16"	13/16" x 3/8"	1-1/4"	10	[H]
Z281-12	12" CC appl. handle	12-3/4"	1-9/16" x 3/4"	2-1/16"	5	[K]
Z281-18	18" CC appl. handle	18-3/4"	1-9/16" x 3/4"	2-1/16"	5	[K]

Finishes



ABSB
Antique Brushed
Satin Brass



BNBDL
Brushed Pewter
(0251 only)



BNDL
Distressed Pewter



DBAC
Brushed Oil
Rubbed Bronze



SN
Satin Nickel



Knobs	Description	Overall Length	Foot Width x Length	Projection	Inner Box	Price Code
519	T-knob	1-9/16"	1/2" x 1/2"	1-1/4"	30	[F]

Pulls	Center-to-Center	Overall Length	Foot Width x Length	Projection	Inner Box	Price Code
519-96	96 mm (3-3/4") CC	4-1/4"	3/4" x 1/2"	1-3/16"	10	[H]
519-128	128 mm (5-1/16") CC	5-9/16"	3/4" x 1/2"	1-3/16"	10	[K]
519-160	160 mm (6-5/16") CC	6-13/16"	3/4" x 1/2"	1-3/16"	10	[K]
519-12	12" CC appl. handle	12-1/2"	3/4" x 1/2"	1-1/2"	5	[K]
519-18	18" CC appl. handle	18-1/2"	3/4" x 1/2"	1-1/2"	5	[K]

Finishes



ABSB

Antique Brushed
Satin Brass

BNBDL

Brushed Pewter

DBAC

Brushed Oil
Rubbed Bronze

NI

Polished Nickel

SN

Satin Nickel



Knobs	Description	Overall Length	Foot Width x Length	Projection	Inner Box	Price Code
585	small square knob	1"	3/4" x 3/4"	1"	20	[F]
585L	large square knob	1-1/4"	3/4" x 3/4"	1"	20	[G]

Pulls	Center-to-Center	Overall Length	Foot Width x Length	Projection	Inner Box	Price Code
585-96	96 mm (3-3/4") CC	4-1/2"	11/16" x 5/8"	1-1/8"	10	[H]
585-128	128 mm (5-1/16") CC	5-13/16"	11/16" x 5/8"	1-1/8"	10	[J]
585-160	160 mm (6-5/16") CC	7-1/16"	11/16" x 5/8"	1-1/8"	10	[K]
585-12	12" CC appl. handle	13-1/4"	3/4" x 7/8"	1-1/2"	5	[K]

Finishes





Knobs	Description	Overall Length	Foot Width x Length	Projection	Inner Box	Price Code
3980	round knob	1-1/4"	1" x 1"	1"	20	[F]

Pulls	Center-to-Center	Overall Length	Foot Width x Length	Projection	Inner Box	Price Code
Z290-3	3" CC	3-3/8"	3/8" x 3/8"	1-5/16"	25	[D]
Z290-96	96 mm (3-3/4") CC	4-1/4"	1/2" x 1/2"	1-5/16"	20	[D]
Z290-128	128 mm (5-1/16") CC	5-1/2"	1/2" x 1/2"	1-7/16"	15	[G]
Z290-160	160 mm (6-5/16") CC	6-3/4"	1/2" x 1/2"	1-9/16"	10	[H]
Z290-12	12" CC appl. handle	13"	1" x 1"	2-1/8"	5	[K]

Finishes



ABSB
Antique
Brushed
Satin Brass

BNBDL
Brushed
Pewter

DACM
Gun
Metal

DBAC
Brushed Oil
Rubbed
Bronze

MB
Matte
Black

ORB
Dark
Bronze

PC
Polished
Chrome

SN
Satin
Nickel

Dominique



Knobs	Description	Overall Length	Foot		Projection	Inner Box	Price Code
			Width x Length				
845	square knob	1-1/8"	7/16" x 7/16"		1-3/16"	20	[D]
845T	T-knob	2"	3/8" x 3/8"		1-3/16"	20	[D]
845TL	long T-knob	2-1/4"	3/8" x 3/8"		1-3/16"	20	[E]

Pulls	Center-to-Center	Overall Length	Foot		Projection	Inner Box	Price Code
			Width x Length				
845-96	96 mm (3-3/4") CC	5-3/4"	5/16" x 5/16"		1-3/16"	10	[F]
845-128	128 mm (5-1/16") CC	7-1/16"	5/16" x 5/16"		1-3/16"	10	[F]
845-160	160 mm (6-5/16") CC	8-5/16"	5/16" x 5/16"		1-3/16"	10	[G]
845-192	192 mm (7-9/16") CC	9-9/16"	5/16" x 5/16"		1-3/16"	10	[H]
845-305	305 mm (12") CC	14"	5/16" x 5/16"		1-3/16"	10	[K]
845-12	12" CC appl. handle	15"	1/2" x 1/2"		1-7/8"	5	[K]
845-18	18" CC appl. handle	21"	1/2" x 1/2"		1-7/8"	5	[K]



DARING

Dominique fuses daring lines with a delicate contour, resulting in a perfect balance of grace and power. With an abundance of pull lengths and knob shapes to choose from, this collection is a winning choice for transitional and contemporary designs.



Shown in Satin Bronze

Finishes



BG
Brushed
Gold



BNBDL
Brushed
Pewter



DBAC
Brushed Oil
Rubbed
Bronze



MB
Matte
Black



PC
Polished
Chrome



SBZ
Satin
Bronze



SN
Satin
Nickel



Shown in Satin Bronze

BOUNDLESS

Elara's chic, European style brings a fresh, upscale perspective to any room. Mix bold round knobs with elegantly curved pinch pulls for boundless design possibilities.

Finishes



BNBDL
Brushed Pewter



DBAC
Brushed Oil
Rubbed Bronze



MB
Matte Black



PC
Polished
Chrome



SBZ
Satin Bronze



SN
Satin Nickel



Knobs	Description	Overall Length	Foot Width x Length	Projection	Inner Box	Price Code
484	round knob	1-1/4"	7/8" x 7/8"	15/16"	20	[D]

Pulls	Center-to-Center	Overall Length	Foot Width x Length	Projection	Inner Box	Price Code
484-32	32 mm (1-1/4") CC	2-1/8"	9/16" x 2-1/8"	15/16"	15	[D]
484-396	3" CC & 96 mm (3-3/4") CC	4-5/8"	9/16" x 4-5/8"	15/16"	20	[F]
484-128160	128 mm (5-1/16") CC & 160 mm (6-5/16") CC	7-1/8"	9/16" x 7-1/8"	15/16"	10	[H]
484-192224	192 mm (7-9/16") CC & 224 mm (8-13/16") CC	9-5/8"	9/16" x 9-5/8"	15/16"	15	[J]
484-305	305 mm (12") CC	12-13/16"	9/16" x 12-13/16"	15/16"	5	[K]

Design Idea

Create a snag-free space (like in closets and laundry rooms) by choosing pulls that have feet that touch the face of the cabinet instead of having an overhang.

3 pull sizes offer 2 center-to-center options

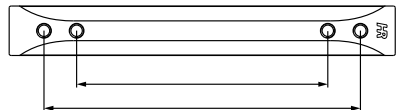



Knobs	Description	Overall Length	Foot Width x Length	Projection	Inner Box	Price Code
165	geometric knob	1-1/4"	9/16" x 13/16"	1-1/8"	20	[E]

Pulls	Center-to-Center	Overall Length	Foot Width x Length	Projection	Inner Box	Price Code
165-96	96 mm (3-3/4") CC	4-1/2"	15/16" x 3/4"	1-3/16"	10	[G]
165-128	128 mm (5-1/16") CC	5-13/16"	15/16" x 3/4"	1-3/16"	10	[H]
165-160	160 mm (6-5/16") CC	7-1/16"	15/16" x 3/4"	1-3/16"	10	[J]
165-12	12" CC appl. handle	13"	1-1/4" x 1"	1-5/8"	5	[K]

Finishes



BNBDL
Brushed Pewter



DBAC
Brushed Oil
Rubbed Bronze



NI
Polished Nickel



PC
Polished Chrome



SN
Satin Nickel



Knobs	Description	Overall Length	Foot Width x Length	Projection	Inner Box	Price Code
G110	small oval	1-1/4"	7/8" x 7/8"	1-3/8"	10	[G]
G110L	large oval	1-5/8"	7/8" x 7/8"	1-11/16"	10	[J]
G120	small button	1-7/16"	7/8" x 7/8"	1-9/16"	10	[G]
G120L	large button	1-3/4"	7/8" x 7/8"	1-5/8"	10	[J]
G130	small sphere	1-1/16"	11/16" x 11/16"	1-7/16"	10	[G]
G130L	large sphere	1-3/8"	7/8" x 7/8"	1-5/8"	10	[H]
G140	small square	1"	11/16" x 11/16"	1-3/16"	10	[G]
G140L	large square	1-3/8"	7/8" x 7/8"	1-5/16"	10	[J]
G150	small faceted	1"	11/16" x 11/16"	1-1/4"	10	[G]
G150L	large faceted	1-1/4"	7/8" x 7/8"	1-1/2"	10	[H]

The Harlow knobs have a post that needs an easy extra step to achieve a flush mount. Once you have drilled your hole with a 3/16" bit, use a 1/4" bit to expand the hole on the face of the door/drawer front to seat the post of the Harlow knob.

Base Finishes



Hayworth

US Patent #
D787,297; D787,296



Knobs	Description	Overall Length	Foot Width x Length	Projection	Inner Box	Price Code
885	round knob	1-1/8"	3/8" x 3/8"	1-7/16"	25	[E]
885L	T-knob	2"	3/8" x 3/8"	1-3/8"	25	[E]

Pulls	Center-to-Center	Overall Length	Foot Width x Length	Projection	Inner Box	Price Code
885-96	96 mm (3-3/4") CC	4-3/4"	3/8" x 3/8"	1-3/8"	10	[G]
885-128	128 mm (5-1/16") CC	6"	3/8" x 3/8"	1-3/8"	10	[H]
885-160	160 mm (6-5/16") CC	7-1/4"	3/8" x 3/8"	1-3/8"	10	[H]
885-192	192 mm (7-9/16") CC	8-1/2"	3/8" x 3/8"	1-3/8"	10	[J]
885-224	224 mm (8-13/16") CC	9-3/4"	3/8" x 3/8"	1-3/8"	10	[J]
885-305	305 mm (12") CC pull	12-15/16"	3/8" x 3/8"	1-3/8"	10	[K]



INDUSTRIAL

Industrial and elegant styles are not often paired together, but Hayworth personifies this combination. The simple yet trendy pull and knob collection offers a clean design while providing a substantial profile through its stepped detail.

Design Idea

Shake things up and strategically mix in matching acrylic knobs and pulls from Carmen with Hayworth to make a fun statement. Find the Carmen Collection on pages 18–19.



Shown in Satin Bronze

Finishes



BG

Brushed Gold



MB

Matte Black



NI

Polished Nickel



PC

Polished Chrome



SBZ

Satin Bronze



SN

Satin Nickel



Knobs	Description	Overall Length	Foot Width x Length	Projection	Inner Box	Price Code
650	oval knob	1-7/8"	5/8" x 5/8"	1"	25	[D]

Pulls	Center-to-Center	Overall Length	Foot Width x Length	Projection	Inner Box	Price Code
650-96	96 mm (3-3/4") CC	4-3/8"	7/8" x 5/8"	1-1/4"	30	[E]
650-128	128 mm (5-1/16") CC	5-11/16"	7/8" x 5/8"	1-1/4"	25	[F]
650-160	160 mm (6-5/16") CC	6-15/16"	7/8" x 5/8"	1-3/8"	10	[G]
650-12	12" CC appl. handle	13"	1-3/8" x 1"	1-9/16"	5	[K]

Finishes



BNBDL
Brushed Pewter



DBAC
Brushed Oil
Rubbed Bronze



PC
Polished Chrome



SN
Satin Nickel



Knobs	Description	Overall Length	Foot Width x Length	Projection	Inner Box	Price Code
188	small knob	7/8"	11/16" x 11/16"	1-3/8"	20	[E]
188L	large knob	1"	13/16" x 13/16"	1-7/16"	15	[F]

Pulls	Center-to-Center	Overall Length	Foot Width x Length	Projection	Inner Box	Price Code
188-96	96 mm (3-3/4") CC	4-3/8"	5/8" x 5/8"	1-7/16"	15	[G]
188-128	128 mm (5-1/16") CC	5-11/16"	5/8" x 5/8"	1-7/16"	15	[H]
188-160	160 mm (6-5/16") CC	6-15/16"	5/8" x 5/8"	1-7/16"	10	[J]

Finishes



BNBDL
Brushed Pewter



DBAC
Brushed Oil
Rubbed Bronze



PC
Polished Chrome



SN
Satin Nickel

Key Grande



Knob	Description	Overall Length	Foot Width x Length	Projection	Inner Box	Price Code
51	T-Knob	2"	7/16" x 3/8"	1-5/16"	20	[H]
Pulls	Center-to-Center	Overall Length	Foot Width x Length	Projection	Inner Box	Price Code
596	96 mm (3-3/4") CC	5-3/8"	7/16" x 3/8"	1-5/16"	20	[H]
5128	128 mm (5-1/16") CC	6-5/8"	7/16" x 3/8"	1-5/16"	20	[H]
5192	192 mm (7-9/16") CC	9-1/8"	7/16" x 3/8"	1-5/16"	10	[J]
5224	224 mm (8-13/16") CC	10-3/8"	7/16" x 3/8"	1-5/16"	10	[J]
5319	319 mm (12-9/16") CC	14-1/8"	7/16" x 3/8"	1-5/16"	10	[K]
5480*	480 mm (18-7/8") CC	20-1/2"	7/16" x 3/8"	1-5/16"	10	[K]
5673*	673 mm (26-1/2") CC	28-1/16"	7/16" x 3/8"	1-5/16"	10	[K]
5900*	900 mm (35-7/16") CC	37"	7/16" x 3/8"	1-5/16"	5	[K]

*Available in Satin Nickel only



Shown in Brushed Gold

REFINED

The simple, clean lines of this beveled bar pull blend with any cabinet style in kitchens, baths, and even laundry rooms. Key Grande's added strap detail offers a refined upgrade to the traditional bar pull.

Finishes



BG
Brushed Gold
(up to 319 mm CC)



MB
Matte Black
(up to 319 mm CC)



SN
Satin Nickel
(all lengths)



MBBG
Matte Black
w/ Brushed Gold
(up to 319 mm CC)



MBSN
Matte Black
w/ Satin Nickel
(up to 319 mm CC)



ENDURING

The enduring bar pull design is comfortable, distinguished, and always a crowd-pleaser. Expanded to offer top-trending finishes and extended lengths for oversized drawers, the presence of Key West and Key Largo will stand the test of time.



Shown in Matte Black

Finishes



BG

Brushed Gold
(up to 320 mm CC)



MB

Matte Black
(up to 320 mm CC)



ORB

Dark Bronze
(up to 178 mm CC)



SBZ

Satin Bronze
(up to 320 mm CC)



SN

Satin Nickel
(all lengths)

Key West & Key Largo



Knobs	Description	Overall Length	Foot Width & Length	Projection	Inner Box	Price Code
48	T-knob	1-7/8"	1/2" x 1/2"	1-7/16"	30	[D]

Pulls	Center-to-Center	Overall Length	Foot Width & Length	Projection	Inner Box	Price Code
146	96 mm (3-3/4") CC	5-3/4"	1/2" x 1/2"	1-7/16"	10	[F]
152	96 mm (3-3/4") CC	6"	1/2" x 1/2"	1-7/16"	10	[F]
178	128 mm (5-1/16") CC	7"	1/2" x 1/2"	1-7/16"	10	[G]
242*	192 mm (7-9/16") CC	9-1/2"	1/2" x 1/2"	1-7/16"	10	[G]
274*	224 mm (8-13/16") CC	10-13/16"	1/2" x 1/2"	1-7/16"	10	[H]
370*	320mm (12-5/8") CC	14-9/16"	1/2" x 1/2"	1-7/16"	10	[H]
530†	480 mm (18-7/8") CC	20-7/8"	1/2" x 1/2"	1-7/16"	10	[J]
722†	673 mm (26-1/2") CC	28-7/16"	1/2" x 1/2"	1-7/16"	10	[K]
950†	900 mm (35-7/16") CC	37-3/8"	1/2" x 1/2"	1-7/16"	10	[K]

*Available in Brushed Gold, Matte Black, Satin Bronze, and Satin Nickel finishes
 †Only available in Satin Nickel finish

Design Idea

For a streamlined and more modern look, choose longer pulls to complement wider drawers.

Lafayette

JEFFREY ALEXANDER®
by Hardware Resources

US Patent #
D605,924; D602,334; D637,059



Knobs	Description	Overall Length	Foot Width & Length	Projection	Inner Box	Price Code
218	fleur-de-lis knob	1-3/8"	7/8" x 7/8"	1-1/4"	30	[F]
317	circles knob	1-3/8"	11/16" x 11/16"	1-1/8"	20	[F]
417	Baroque pattern knob	1-3/8"	3/4" x 3/4"	1-1/8"	30	[F]

Pulls	Center-to-Center	Overall Length	Foot Width & Length	Projection	Inner Box	Price Code
317-96	96 mm (3-3/4") CC	4-3/8"	9/16" x 9/16"	1-1/4"	20	[G]
317-128	128 mm (5-1/16") CC	5-5/8"	9/16" x 9/16"	1-3/8"	20	[H]
317-160	160 mm (6-5/16") CC	6-7/8"	9/16" x 9/16"	1-7/16"	15	[H]
317-12	12" CC appl. handle	12-15/16"	7/8" x 7/8"	2-3/16"	5	[K]

Finishes



ABSB
Antique Brushed
Satin Brass



BNBDL
Brushed Pewter



DBAC
Brushed Oil
Rubbed Bronze



SN
Satin Nickel



Knobs	Description	Overall Length	Foot Width x Length	Projection	Inner Box	Price Code
3991	oval knob	1-9/16"	11/16" x 11/16"	1-5/8"	25	[E]

Pulls	Center-to-Center	Overall Length	Foot Width x Length	Projection	Inner Box	Price Code
8233	3" CC	4-15/16"	4-15/16" x 1-7/16"	1"	25	[D]

Finishes





Shown in Matte Black w/ Satin Bronze

Larkin 1 & 2

EDGY

Edgy with undiluted style, Larkin is making its statement. The classic beveled bar pairs perfectly with its fierce squared foot to create a look that will complement any style of cabinetry. Captivate and inspire with five solid finishes or opt for something moody and expressive with four mixed options.

Larkin 3 & 4

Design Idea

To add even more drama, pair Larkin with its sister collection Spencer, featuring clear acrylic pieces (see pages 68–69).



Shown in
Brushed Gold



Larkin 1 & 2

JEFFREY ALEXANDER®
by Hardware Resources



Knob	Description	Overall Length	Foot Width x Length	Projection	Inner Box	Price Code
478T	T-Knob	2-3/8"	11/16" x 1/2"	1-7/16"	15	[E]

Pulls	Center-to-Center	Overall Length	Foot Width x Length	Projection	Inner Box	Price Code
478-96	96 mm (3-3/4") CC	6-1/8"	11/16" x 1/2"	1-7/16"	10	[F]
478-128	128 mm (5-1/16") CC	7-3/8"	11/16" x 1/2"	1-7/16"	10	[F]
478-160	160 mm (6-5/16") CC	8-11/16"	11/16" x 1/2"	1-7/16"	10	[G]
478-192	192 mm (7-9/16") CC	9-15/16"	11/16" x 1/2"	1-7/16"	10	[G]
478-305	305 mm (12") CC	14-3/8"	11/16" x 1/2"	1-7/16"	5	[K]
478-12	12" CC appl. handle	15-3/16"	1-1/8" x 5/8"	2-3/16"	5	[K]
478-18	18" CC appl. handle	21-3/16"	1-1/8" x 5/8"	2-3/16"	5	[K]

Solid Finishes



Mixed Finishes





Knob	Description	Overall Length	Foot Width x Length	Projection	Inner Box	Price Code	
498T	T-knob	2-3/8"	11/16" x 1/2"	1-7/16"	15	[F]	
Pulls (Knurled Center)		Center-to-Center	Overall Length	Foot Width x Length	Projection	Inner Box	Price Code
598-96	96 mm (3-3/4") CC	6-1/8"	11/16" x 1/2"	1-7/16"	10	[H]	
598-128	128 mm (5-1/16") CC	7-3/8"	11/16" x 1/2"	1-7/16"	10	[H]	
598-160	160 mm (6-5/16") CC	8-11/16"	11/16" x 1/2"	1-7/16"	10	[H]	
598-192	192 mm (7-9/16") CC	9-15/16"	11/16" x 1/2"	1-7/16"	10	[J]	
598-305	305 mm (12") CC	14-3/8"	11/16" x 1/2"	1-7/16"	5	[K]	
598-12	12" CC appl. handle	14-3/8"	1-1/8" x 5/8"	2-3/16"	5	[K]	
598-18	18" CC appl. handle	20-3/8"	1-1/8" x 5/8"	2-3/16"	5	[K]	
Pulls (Knurled Ends)		Center-to-Center	Overall Length	Foot Width x Length	Projection	Inner Box	Price Code
698-96	96 mm (3-3/4") CC	6-1/8"	11/16" x 1/2"	1-7/16"	10	[H]	
698-128	128 mm (5-1/16") CC	7-3/8"	11/16" x 1/2"	1-7/16"	10	[H]	
698-160	160 mm (6-5/16") CC	8-11/16"	11/16" x 1/2"	1-7/16"	10	[H]	
698-192	192 mm (7-9/16") CC	9-15/16"	11/16" x 1/2"	1-7/16"	10	[J]	
698-305	305 mm (12") CC	14-3/8"	11/16" x 1/2"	1-7/16"	5	[K]	
698-12	12" CC appl. handle	14-3/8"	1-1/8" x 5/8"	2-3/16"	5	[K]	
698-18	18" CC appl. handle	20-3/8"	1-1/8" x 5/8"	2-3/16"	5	[K]	

Finishes



BG
Brushed Gold



MB
Matte Black



SBZ
Satin Bronze



SN
Satin Nickel

Leyton



Pulls	Center-to-Center	Overall Length	Foot Width x Length	Projection	Inner Box	Price Code
286-96	96 mm (3-3/4") CC	5-1/8"	5/16" x 7/8"	1-3/16"	10	[F]
286-128	128 mm (5-1/16") CC	6-3/8"	5/16" x 7/8"	1-3/16"	10	[G]
286-160	160 mm (6-5/16") CC	7-11/16"	5/16" x 7/8"	1-3/16"	10	[H]
286-192	192 mm (7-9/16") CC	8-15/16"	5/16" x 7/8"	1-3/16"	10	[H]
286-224	224 mm (8-13/16") CC	10-3/16"	5/16" x 7/8"	1-3/16"	10	[J]

Finishes



BNBDL
Brushed Pewter



DBAC
Brushed Oil
Rubbed Bronze



MB
Matte Black



NI
Polished Nickel



PC
Polished Chrome



SBZ
Satin Bronze



SN
Satin Nickel



DISTINCTIVE

Leyton's relaxed yet distinctive asymmetrical silhouette is fun and flexible. An ideal complement to mid-century modern design with its clean lines and gentle curves, this pull collection also harmonizes with contemporary design's straight lines and geometric shapes.

Design Idea

For a bold, modern feel, use gold-tone hardware on black cabinets.



Shown in Matte Black



Shown in
Brushed Oil Rubbed Bronze

NOTABLE

The Loxley cabinet knob and pull collection is a notable example of elegant simplicity. With its soft and clean design, Loxley effortlessly melds with a variety of decor styles. Its two distinct cabinet knob shapes, round and rounded rectangle, complement its vast array of pull lengths. Each pull features a rounded grip, ensuring a comfortable feel in the hand. With seven beautiful finishes to choose from, this collection reflects meticulous craftsmanship, adding a subtle yet impressive touch of sophistication to any living space.

Loxley

New collection



Knob	Description	Overall Length	Foot Width x Length	Projection	Inner Box	Price Code
329	round knob	1-1/4"	3/8" x 3/8"	1-1/4"	20	[D]
329L	rounded rectangle knob	1-1/2"	3/8" x 3/8"	1-5/16"	20	[D]
Pulls	Center-to-Center	Overall Length	Foot Width x Length	Projection	Inner Box	Price Code
329-96	96 mm (3-3/4") CC	4-9/16"	5/8" x 5/8"	1-3/16"	10	[E]
329-128	128 mm (5-1/16") CC	5-7/8"	5/8" x 5/8"	1-3/16"	10	[F]
329-160	160 mm (6-5/16") CC	7-1/8"	5/8" x 5/8"	1-3/16"	10	[G]
329-192	192 mm (7-9/16") CC	8-7/16"	5/8" x 5/8"	1-3/16"	10	[G]
329-305	305 mm (12") CC	12-15/16"	5/8" x 5/8"	1-3/16"	10	[K]
329-12	12" CC appl. handle	13-7/16"	1" x 1"	1-3/4"	5	[K]
329-18	18" CC appl. handle	19-7/16"	1" x 1"	1-3/4"	5	[K]

Finishes



Marie

US Patent #
D956,510; D968,192

JEFFREY ALEXANDER®
by Hardware Resources



Knobs	Description	Overall Length	Foot Width x Length	Projection	Inner Box	Price Code
445	round knob	1-1/4"	11/16" x 11/16"	1-1/8"	10	[D]

Pulls	Center-to-Center	Overall Length	Foot Width x Length	Projection	Inner Box	Price Code
445-96	96 mm (3-3/4") CC	4-3/8"	5/8" x 5/8"	1-5/16"	10	[E]
445-128	128 mm (5-1/16") CC	5-5/8"	5/8" x 5/8"	1-1/2"	10	[F]
445-160	160 mm (6-5/16") CC	6-7/8"	5/8" x 5/8"	1-1/2"	10	[F]
445-192	192 mm (7-9/16") CC	8-3/16"	5/8" x 5/8"	1-1/2"	10	[G]
445-224	224 mm (8-13/16") CC	9-7/16"	5/8" x 5/8"	1-1/2"	10	[H]
445-305	305 mm (12") CC	12-11/16"	11/16" x 11/16"	1-1/2"	10	[K]
445-12	12" CC appl. handle	13"	1" x 1"	2-1/8"	1	[K]
445-18	18" CC appl. handle	19"	1" x 1"	2-1/8"	1	[K]

Finishes





Knobs	Description	Overall Length	Foot Width x Length	Projection	Inner Box	Price Code
972S	small square knob	7/8"	7/16" x 7/16"	1"	30	[D]
972	medium square knob	1-1/8"	1/2" x 1/2"	1"	30	[E]
972L	large square knob	1-1/4"	9/16" x 9/16"	1"	20	[F]

Pulls	Center-to-Center	Overall Length	Foot Width x Length	Projection	Inner Box	Price Code
972-96	96 mm (3-3/4") CC	4-1/2"	1" x 3/4"	1-1/16"	10	[G]
972-128	128 mm (5-1/16") CC	5-13/16"	1" x 3/4"	1-1/16"	10	[H]
972-160	160 mm (6-5/16") CC	7-1/16"	1" x 3/4"	1-1/16"	10	[J]
972-224	224 mm (8-13/16") CC	9-3/4"	1" x 3/4"	1-1/16"	15	[J]
972-305	305 mm (12") CC	12-3/4"	1" x 3/4"	1-1/16"	10	[K]
972-12	12" CC appl. handle	13"	1-3/8" x 1"	1-1/2"	5	[K]

Finishes



BNBDL
Brushed Pewter



DBAC
Brushed Oil
Rubbed Bronze



NI
Polished Nickel



PC
Polished Chrome



SN
Satin Nickel



Shown in Brushed Pewter

Comfortable

Subtle curves, a broad profile, and square feet make Merrick's simple strap pull anything but boring. A comfortable choice for various cabinet styles, this pull family's versatility makes it a popular preference.

Design Idea

When using two contrasting cabinet finishes, choose the same finish for knobs and pulls to tie everything together, or opt for various finishes that complement the cabinet color, adding more personality to a space.



Shown in Satin Bronze



Pulls	Center-to-Center	Overall Length	Foot Width x Length	Projection	Inner Box	Price Code
549-96	96 mm (3-3/4") CC	4-3/16"	9/16" x 5/8"	1-1/16"	25	[E]
549-128	128 mm (5-1/16") CC	5-1/2"	9/16" x 5/8"	1-1/16"	15	[E]
549-160	160 mm (6-5/16") CC	6-3/4"	9/16" x 5/8"	1-1/16"	15	[F]
549-192	192 mm (7-9/16") CC	8"	9/16" x 5/8"	1-1/16"	20	[F]
549-320	320 mm (12-5/8") CC	13-1/16"	9/16" x 5/8"	1-1/16"	10	[K]

Finishes



BNBDL Brushed Pewter
 DBAC Brushed Oil Rubbed Bronze
 MB Matte Black
 PC Polished Chrome
 SBZ Satin Bronze
 SN Satin Nickel

Milan 1



Knobs	Description	Overall Length	Foot		Inner Box	Price Code
			Width x Length	Projection		
1091	square knob	1-1/4"	13/16" x 13/16"	1"	20	[E]

Pulls	Center-to-Center	Overall Length	Foot		Inner Box	Price Code
			Width x Length	Projection		
1092	96 mm (3-3/4") CC	4-1/4"	1/2" x 1/2"	1-1/16"	20	[F]
1092-128	128 mm (5-1/16") CC	5-9/16"	1/2" x 1/2"	1-1/16"	25	[G]
1092-160	160 mm (6-5/16") CC	6-13/16"	1/2" x 1/2"	1-1/16"	20	[H]
1092-12	12" CC appl. handle	12-3/4"	13/16" x 13/16"	1-3/8"	5	[K]

Finishes





CHARISMATIC

Charismatic and fashionable, the soft square design of Milan 1 has matured from a daring new shape to a timeless classic. The simple stepped square accents and the availability of an appliance pull make this collection a go-to for a variety of cabinet styles.



Shown in Gun Metal



Knobs	Description	Overall Length	Foot		Projection	Inner Box	Price Code
			Width x Length				
81021	16 mm (5/8") CC knob	1-9/16"	1/4" x 7/8"		3/4"	30	[D]

Pulls	Center-to-Center	Overall Length	Foot		Projection	Inner Box	Price Code
			Width x Length				
80152-96	96 mm (3-3/4") CC	5-9/16"	15/16" x 1-1/8"		1"	20	[G]
80152-128	128 mm (5-1/16") CC	6-13/16"	15/16" x 1-1/8"		1"	20	[H]
80152-160	160 mm (6-5/16") CC	8-1/16"	15/16" x 1-5/16"		1-1/8"	15	[H]

Finishes



ABSB
Antique
Brushed
Satin Brass



BNBDL
Brushed
Pewter



DBAC
Brushed Oil
Rubbed
Bronze



MB
Matte Black



PC
Polished
Chrome



SN
Satin Nickel



Pulls	Center-to-Center	Overall Length	Foot Width x Length	Projection	Inner Box	Price Code
847-96	96 mm (3-3/4") CC	5-9/16"	5/8" x 1-1/4"	7/8"	25	[D]
847-128	128 mm (5-1/16") CC	6-13/16"	5/8" x 1-1/4"	7/8"	25	[D]
847-160	160 mm (6-5/16") CC	8-1/16"	5/8" x 1-1/4"	7/8"	25	[D]

Finishes



BNBDL
Brushed Pewter



DBAC
Brushed Oil
Rubbed Bronze



MB
Matte Black



PC
Polished Chrome



SN
Satin Nickel

Philip



Knobs	Description	Overall Length	Foot Width x Length	Projection	Inner Box	Price Code
767	rectangle knob	1-1/4"	1/2" x 3/4"	1-1/16"	25	[D]

Pulls	Center-to-Center	Overall Length	Foot Width x Length	Projection	Inner Box	Price Code
767-96	96 mm (3-3/4") CC	5-1/16"	11/16" x 7/8"	1-1/16"	15	[E]
767-128	128 mm (5-1/16") CC	6-5/16"	3/4" x 7/8"	1-1/8"	10	[F]
767-160	160 mm (6-5/16") CC	7-9/16"	3/4" x 7/8"	1-1/8"	10	[G]

Finishes

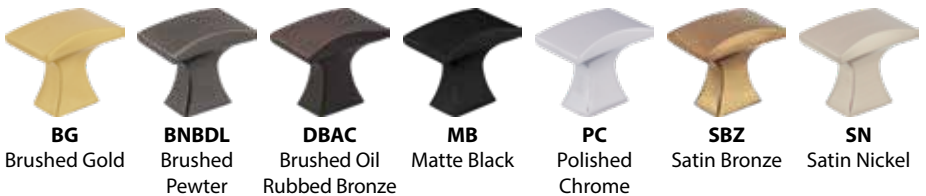

BG
Brushed Gold

BNBDL
Brushed Pewter

DBAC
Brushed Oil Rubbed Bronze

MB
Matte Black

PC
Polished Chrome

SBZ
Satin Bronze

SN
Satin Nickel

JEFFREY ALEXANDER®

by Hardware Resources



Shown in Satin Nickel

PLAYFUL

The playful flare and soft lines of Philip's knob and pull create excitement and a bit of romance. The design options of this lively collection are matchless, making it a winning choice for any kitchen, bath, or closet.

Renzo



Knobs	Description	Overall Length	Foot Width x Length	Projection	Inner Box	Price Code
141	square knob	1-1/4"	3/4" x 3/4"	1-1/8"	10	[D]
141L	large square knob	1-3/4"	3/4" x 3/4"	1-1/8"	10	[D]

Pulls	Center-to-Center	Overall Length	Foot Width x Length	Projection	Inner Box	Price Code
141-96	96 mm (3-3/4") CC	4-5/8"	1-1/4" x 4-5/8"	1"	10	[E]
141-128	128 mm (5-1/16") CC	5-7/8"	1-1/4" x 5-7/8"	1"	10	[F]
141-160	160 mm (6-5/16") CC	7-1/8"	1-1/4" x 7-1/8"	1"	10	[G]
141-192	192 mm (7-9/16") CC	8-3/8"	1-1/4" x 8-3/8"	1"	10	[H]
141-305	305 mm (12") CC	12-7/8"	1-1/4" x 12-7/8"	1"	10	[K]

Finishes

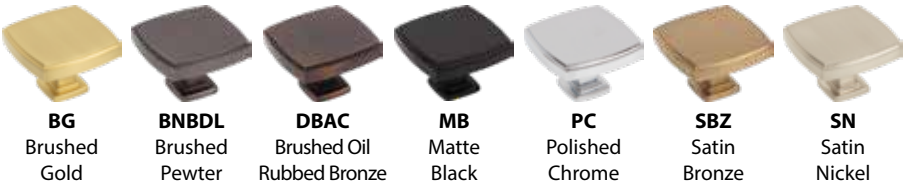



DEBONAIR

Thoughtfully balanced lines blend with a boldly stepped profile in Renzo, resulting in a strong and debonair presence. Revitalizing the admired cup pull with its modern squared shape, this adaptable collection enhances the look of almost any cabinet style while adding functionality with its dual-hole mounting options.



Shown in Satin Bronze

Center mount: use when the mounting holes are positioned in the center of the drawer front



Lower mount: use when the mounting holes are positioned lower on the drawer front

Design Idea

Pair Renzo's cup pulls with Richard's standard pulls or appliance handles to create a modernistic and refined presence in any space. Find the Richard Collection on pages 60–61.

Richard



Knobs	Description	Overall Length	Foot Width x Length	Projection	Inner Box	Price Code
171	round knob	1-1/4"	3/4" x 3/4"	1-1/8"	20	[D]
171L	large round knob	1-3/4"	3/4" x 3/4"	1-1/8"	10	[E]

Pulls	Center-to-Center	Overall Length	Foot Width x Length	Projection	Inner Box	Price Code
171-96	96 mm (3-3/4") CC	4-3/8"	13/16" x 9/16"	1-1/8"	10	[F]
171-128	128 mm (5-1/16") CC	5-5/8"	13/16" x 9/16"	1-1/8"	10	[F]
171-160	160 mm (6-5/16") CC	6-7/8"	13/16" x 9/16"	1-1/8"	10	[G]
171-192	192 mm (7-9/16") CC	8-1/8"	13/16" x 9/16"	1-1/8"	10	[G]
171-305	305 mm (12") CC	12-5/8"	13/16" x 9/16"	1-1/8"	10	[K]
171-12	12" CC appl. handle	12-13/16"	1-1/8" x 13/16"	1-5/8"	5	[K]
171-18	18" CC appl. handle	18-13/16"	1-1/8" x 13/16"	1-5/8"	5	[K]

Finishes





Shown in Satin Nickel

MODERNISTIC

The combination of a stately stepped profile and structured soft-square shape gives Richard an air of modernistic magnificence. Long balanced lines are echoed in both its pulls and knobs, adding charisma to any style cabinet it is coupled with.

Design Idea

Pair Richard's standard pulls or appliance handles with the Renzo cup pulls to create a modern, debonair presence in any space. Find the Renzo Collection on pages 58–59.



Shown in Brushed Gold

INSPIRING

A flowing arch and strong structured foot make an inspiring and compelling combination for this knob and pull collection. The high arch of Roman's pull discreetly adds the additional height aging in place and ADA projects require while presenting a refined look.

Finishes



BG
Brushed Gold



BNBDL
Brushed Pewter



DBAC
Brushed Oil Rubbed Bronze



MB
Matte Black



NI
Polished Nickel



PC
Polished Chrome



SBZ
Satin Bronze



SN
Satin Nickel

Roman

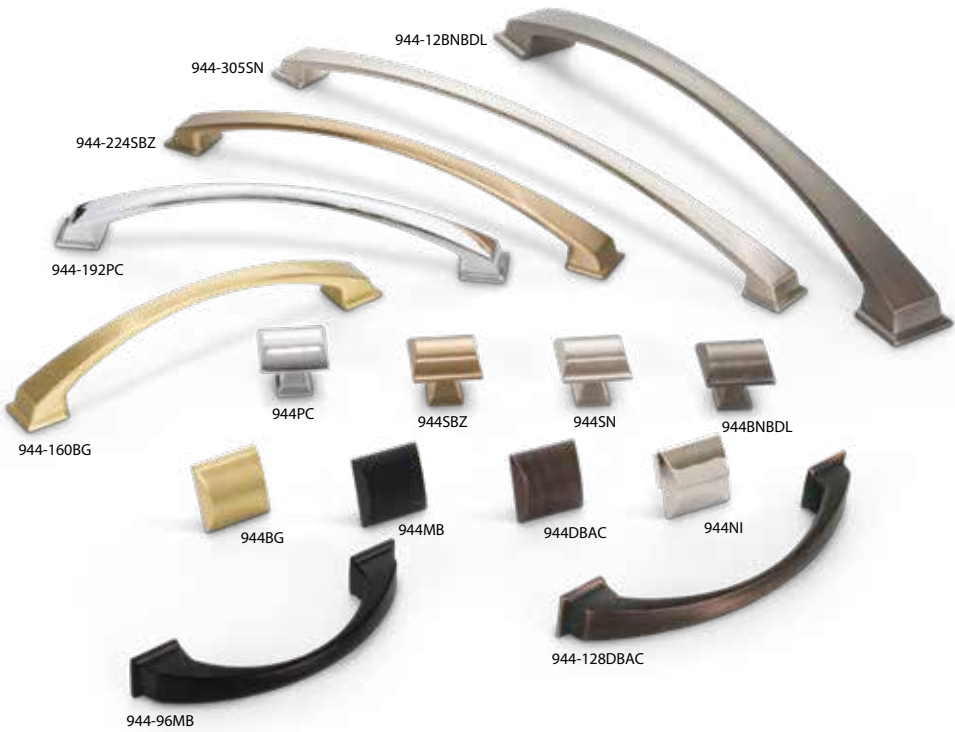

Knobs	Description	Overall Length	Foot Width x Length	Projection	Inner Box	Price Code
944	square knob	1-1/4"	5/8" x 5/8"	1-1/8"	20	[D]

Pulls	Center-to-Center	Overall Length	Foot Width x Length	Projection	Inner Box	Price Code
944-96	96 mm (3-3/4") CC	4-15/16"	13/16" x 13/16"	1-7/16"	10	[E]
944-128	128 mm (5-1/16") CC	6-1/4"	7/8" x 7/8"	1-7/16"	10	[F]
944-160	160 mm (6-5/16") CC	7-1/2"	7/8" x 7/8"	1-7/16"	10	[F]
944-192	192 mm (7-9/16") CC	8-3/4"	15/16" x 7/8"	1-7/16"	10	[G]
944-224	224 mm (8-13/16") CC	10"	15/16" x 7/8"	1-1/2"	15	[H]
944-305	305 mm (12") CC	13-3/16"	15/16" x 7/8"	1-9/16"	10	[K]
944-12	12" CC appl. handle	13-5/8"	1-3/8" x 1-3/16"	1-7/8"	5	[K]



Knobs	Description	Overall Length	Foot		Inner Box	Price Code
			Width x Length	Projection		
431	soft square knob	1-3/16"	9/16" x 9/16"	15/16"	30	[D]
595	pyramid knob	1-1/4"	5/8" x 5/8"	7/8"	20	[D]

Pulls	Center-to-Center	Overall Length	Foot		Inner Box	Price Code
			Width x Length	Projection		
798-96	96 mm (3-3/4") CC	5-1/2"	9/16" x 1"	1"	10	[E]
798-128	128 mm (5-1/16") CC	6-3/4"	9/16" x 1"	1"	10	[F]
798-160	160 mm (6-5/16") CC	8-1/16"	9/16" x 1"	1"	10	[G]

Finishes



BNBDL
Brushed Pewter



DBAC
Brushed Oil
Rubbed Bronze



PC
Polished Chrome



SN
Satin Nickel



Knobs	Description	Overall Length	Foot Width x Length	Projection	Inner Box	Price Code
431	soft square knob	1-3/16"	9/16" x 9/16"	15/16"	30	[D]
Pulls	Center-to-Center	Overall Length	Foot Width x Length	Projection	Inner Box	Price Code
4128	128 mm (5-1/16") CC	6-3/16"	5/8" x 3/4"	1-1/8"	20	[F]
4160	160 mm (6-5/16") CC	8"	11/16" x 1"	1-3/16"	20	[G]
4192	192 mm (7-9/16") CC	9-1/2"	11/16" x 1-1/4"	1-3/16"	20	[H]
4288	288 mm (11-5/16") CC	14-7/16"	13/16" x 1-3/4"	1-1/4"	10	[K]

Finishes



BNBDL
Brushed Pewter



DBAC
Brushed Oil
Rubbed Bronze



MB
Matte Black



PC
Polished Chrome



SN
Satin Nickel

Southerland

New collection



Knobs	Description	Overall Length	Foot Width x Length	Projection	Inner Box	Price Code
686	small clover knob	1-1/4"	1/2" x 1/2"	1-1/4"	20	[D]
686L	large clover knob	1-1/2"	5/8" x 5/8"	1-7/16"	15	[E]

Pulls	Center-to-Center	Overall Length	Foot Width x Length	Projection	Inner Box	Price Code
686-96	96 mm (3-3/4") CC	4-1/8"	9/16" x 9/16"	1-1/2"	15	[F]
686-128	128 mm (5-1/16") CC	5-3/8"	9/16" x 9/16"	1-1/2"	15	[F]
686-160	160 mm (6-5/16") CC	6-11/16"	9/16" x 9/16"	1-1/2"	10	[G]

Finishes



DBAC
Brushed Oil
Rubbed Bronze



MB
Matte Black



PC
Polished Chrome



SBZ
Satin Bronze



SN
Satin Nickel



UNFORGETTABLE

Discover the unforgettable elegance of Southerland, an incomparable collection of knobs and pulls designed to add a touch of timeless beauty to any space. The pulls are available in three standard lengths, while the two sizes of knobs offer a delicate yet impactful embellishment. Transform any room with Southerland's clover-inspired design, where every detail tells the story of exquisite taste and charm.



Shown in Satin Bronze



Shown in Matte Black

ICONIC

The pairing of a contemporary square foot with a crystal-clear acrylic bar in the Spencer Collection creates a captivatingly iconic finishing touch to any cabinet or furniture piece it adorns. This collection finds the perfect balance between opulence and approachable elegance.

Design Idea

Mix things up and pair Spencer with its sister collection Larkin, available in solid finishes and mixed finishes, to add an edgy touch to this iconically fashionable look. Find the Larkin Collection on pages 40–43.



Knobs	Description	Overall Length	Foot		Inner Box	Price Code
			Width x Length	Projection		
578T	T-knob	2-3/8"	11/16" x 7/8"	1/2"	30	[E]

Pulls	Center-to-Center	Overall Length	Foot		Inner Box	Price Code
			Width x Length	Projection		
578-96	96 mm (3-3/4") CC	6-1/8"	11/16" x 1/2"	1-7/16"	10	[F]
578-128	128 mm (5-1/16") CC	7-3/8"	11/16" x 1/2"	1-7/16"	10	[F]
578-160	160 mm (6-5/16") CC	8-11/16"	11/16" x 1/2"	1-7/16"	10	[G]

Finishes



BG
Brushed Gold

MB
Matte Black

PC
Polished Chrome

SBZ
Satin Bronze

SN
Satin Nickel

Sullivan



Knobs	Description	Overall Length	Foot Width x Length	Projection	Inner Box	Price Code
752-19	19 mm (3/4") CC knob	1-1/4"	3/4" x 1-1/4"	1-1/16"	25	[D]
Pulls	Center-to-Center	Overall Length	Foot Width x Length	Projection	Inner Box	Price Code
752-96	96 mm (3-3/4") CC	4-1/2"	3/4" x 3/4"	1-3/16"	20	[D]
752-128	128 mm (5-1/16") CC	5-13/16"	3/4" x 3/4"	1-3/16"	10	[F]
752-160	160 mm (6-5/16") CC	7-1/16"	3/4" x 3/4"	1-3/16"	10	[G]
752-192	192 mm (7-9/16") CC	8-5/16"	3/4" x 3/4"	1-3/16"	10	[G]
752-224	224 mm (8-13/16") CC	9-9/16"	3/4" x 3/4"	1-3/16"	10	[H]



POWERFUL

Reflecting the brawn of I-beams softened by gentle undercurves and tapered feet, Sullivan radiates a powerful yet serene presence. With a coordinating knob that echoes the pull's strong silhouette, this collection is adaptable to raised or flat panel cabinets.



Shown in Brushed Pewter

Finishes



BNBDL
Brushed Pewter



DBAC
Brushed Oil
Rubbed Bronze



MB
Matte Black



PC
Polished Chrome



SN
Satin Nickel



Shown in Brushed Gold

WARM

Sutton's square profile is softened with a warm and graceful curve that flows around the handgrip all the way down to its feet. The narrow design of these pulls can make both a fearless statement and whisper sophistication with the perfect finish choice.



Pulls	Center-to-Center	Overall Length	Foot Width x Length	Projection	Inner Box	Price Code
635-32	32 mm (1-1/4") CC	2-1/4"	5/16" x 11/16"	1"	30	[E]
635-96	96 mm (3-3/4") CC	4-3/4"	5/16" x 13/16"	1-1/16"	25	[F]
635-128	128 mm (5-1/16") CC	5-7/8"	5/16" x 13/16"	1-1/16"	20	[F]
635-160	160 mm (6-5/16") CC	7-1/2"	3/8" x 7/8"	1-1/16"	10	[G]
635-256	256 mm (10-1/16") CC	11-7/16"	3/8" x 1"	1-1/8"	20	[K]

Finishes



BG
Brushed Gold



BNBDL
Brushed Pewter



DBAC
Brushed Oil
Rubbed Bronze



MB
Matte Black



NI
Polished Nickel



PC
Polished Chrome



SBZ
Satin Bronze



SN
Satin Nickel

Tiffany

US Patent #
D792,188



Knobs	Description	Overall Length	Foot		Projection	Inner Box	Price Code
			Width x Length				
658	round knob	1-1/4"	7/8" x 7/8"		1-5/16"	20	[F]

Pulls	Center-to-Center	Overall Length	Foot		Projection	Inner Box	Price Code
			Width x Length				
658-96	96 mm (3-3/4") CC	4-1/2"	3/4" x 3/4"		1-5/16"	20	[G]
658-128	128 mm (5-1/16") CC	5-13/16"	3/4" x 3/4"		1-5/16"	15	[H]
658-160	160 mm (6-5/16") CC	7-1/16"	3/4" x 3/4"		1-3/8"	10	[J]
658-192	192 mm (7-9/16") CC	8-3/8"	13/16" x 13/16"		1-3/8"	15	[J]
658-224	224 mm (8-13/16") CC	9-7/8"	7/8" x 7/8"		1-1/2"	15	[K]
658-12	12" CC appl. handle	13"	1" x 1"		2"	5	[K]



Shown in Brushed Gold

ELEGANT

Tiffany combines a classically elegant shape with a transitional twist for a look that is timeless. This pull and knob collection features matching step details throughout the hardware design, accompanied by flowing curves for a comfortable feel in your hand.

Finishes



BG
Brushed Gold



BNBDL
Brushed Pewter



DBAC
Brushed Oil Rubbed Bronze



NI
Polished Nickel



PC
Polished Chrome



SBZ
Satin Bronze



SN
Satin Nickel

Tahoe

JEFFREY ALEXANDER®
by Hardware Resources

US Patent #
D602,330; D598,270



Knobs	Description	Overall Length	Foot Width x Length	Projection	Inner Box	Price Code
602S	small square knob	1-1/4"	9/16" x 9/16"	1-3/16"	30	[G]
602	large square knob	1-1/2"	9/16" x 9/16"	1-1/4"	25	[G]

Pulls	Center-to-Center	Overall Length	Foot Width x Length	Projection	Inner Box	Price Code
602-96	96 mm (3-3/4") CC	4-1/2"	3/4" x 3/4"	1-5/16"	10	[H]
602-128	128 mm (5-1/16") CC	5-13/16"	3/4" x 3/4"	1-3/8"	10	[J]
602-12	12" CC appl. handle	12-3/4"	3/4" x 3/4"	1-3/8"	5	[K]

Finishes



BLK
Black



DMAC
Distressed Oil
Rubbed Bronze



SIM
Distressed Antique
Silver



Knobs	Description	Overall Length	Foot Width x Length	Projection	Inner Box	Price Code
678	geometric knob	1-1/4"	3/4" x 3/4"	1-3/16"	20	[D]

Pulls	Center-to-Center	Overall Length	Foot Width x Length	Projection	Inner Box	Price Code
678-96	96 mm (3-3/4") CC	5"	13/16" x 13/16"	1-1/16"	10	[F]
678-128	128 mm (5-1/16") CC	6-1/4"	13/16" x 13/16"	1-1/16"	10	[G]
678-160	160 mm (6-5/16") CC	7-1/2"	13/16" x 13/16"	1-1/16"	10	[G]
678-18	18" CC appl. handle	20-1/4"	1-3/8" x 1-3/8"	2"	5	[K]

Finishes



BG
Brushed Gold

BNBDL
Brushed Pewter

DBAC
Brushed Oil Rubbed Bronze

MB
Matte Black

PC
Polished Chrome

SBZ
Satin Bronze

SN
Satin Nickel

Whitlock

New collection



Knobs	Description	Overall Length	Foot		Inner Box	Price Code
			Width x Length	Projection		
905	square knob	1-1/4"	5/16" x 5/16"	1-3/16"	20	[D]

Pulls	Center-to-Center	Overall Length	Foot		Inner Box	Price Code
			Width x Length	Projection		
905-96	96 mm (3-3/4") CC	5"	5/16" x 5/16"	1-3/8"	10	[F]
905-128	128 mm (5-1/16") CC	6-1/4"	5/16" x 5/16"	1-3/8"	10	[G]
905-160	160 mm (6-5/16") CC	7-1/2"	5/16" x 5/16"	1-3/8"	10	[G]
905-192	192 mm (7-9/16") CC	8-3/4"	5/16" x 5/16"	1-3/8"	10	[H]
905-305	305 mm (12") CC	13-1/4"	5/16" x 5/16"	1-3/8"	10	[K]
905-12	12" CC appl. handle	14-1/2"	7/16" x 7/16"	1-15/16"	5	[K]
905-18*	18" CC appl. handle	20-1/2"	7/16" x 7/16"	1-15/16"	5	[K]

Finishes



BG
Brushed Gold



MB
Matte Black



PC
Polished Chrome



SBZ
Satin Bronze



SN
Satin Nickel



CAPTIVATING

Whitlock's captivating allure lies within its softened square shape, seamlessly uniting contemporary aesthetics with timeless charm. With an array of cabinet pull lengths and a coordinating knob, all available in six on-trend finishes, the versatility of this collection knows no bounds. Whitlock's powerful presence and winning design make it a flawless choice for those seeking to infuse their living spaces with elegance and modernity.



Shown in Matte Black



Shown in Brushed Pewter

UNEXPECTED

The square bar pull structure with dashing strap detail of Zane is an unexpected and charming transformation from the basic bar or square bar pull. Available in extended pull lengths, this collection accents any modern or transitional design scheme with its clean lines and unique presence.



Knobs	Description	Overall Length	Foot Width x Length	Projection	Inner Box	Price Code
293T	T-knob	2"	5/16" x 5/16"	1-1/4"	10	[E]

Pulls	Center-to-Center	Overall Length	Foot Width x Length	Projection	Inner Box	Price Code
293-96	96 mm (3-3/4") CC	5"	5/16" x 5/16"	1-1/4"	10	[G]
293-128	128 mm (5-1/16") CC	6-5/16"	5/16" x 5/16"	1-1/4"	10	[G]
293-160	160 mm (6-5/16") CC	7-9/16"	5/16" x 5/16"	1-1/4"	10	[H]
293-192	192 mm (7-9/16") CC	8-13/16"	5/16" x 5/16"	1-1/4"	10	[H]
293-224	224 mm (8-13/16") CC	10-1/16"	5/16" x 5/16"	1-1/4"	10	[J]
293-305	305 mm (12") CC	13-1/4"	5/16" x 5/16"	1-1/4"	10	[K]

Finishes



BNBDL
Brushed Pewter



MB
Matte Black



NI
Polished Nickel



PC
Polished Chrome



SN
Satin Nickel

The **essentials** and more, priced right



Stanton Collection
on pages 110–111

40+ designs of knobs and pulls in the most popular styles and finishes

Complete line of solid steel and hollow stainless steel bar pulls available in the Naples Collection

Base Metal of cast zinc alloy, steel, aluminum or stainless steel for durability

Machine polished for consistent quality

Also ideal for the commercial, multi-family, retail, and builder markets

Limited Lifetime Warranty



Pulls	Center-to-Center	Overall Length	Foot Width x Length	Projection	Inner Box	Price Code
193-3	3" CC	3-1/4"	3/4" x 1/4"	1-1/8"	15	[D]
193-96	96 mm (3-3/4") CC	4"	3/4" x 1/4"	1-1/8"	15	[D]
193-4	4" CC	4-1/4"	3/4" x 1/4"	1-1/8"	15	[E]
193-128	128 mm (5-1/16") CC	5-1/4"	3/4" x 1/4"	1-1/8"	10	[E]
193-160	160 mm (6-5/16") CC	6-9/16"	3/4" x 1/4"	1-1/8"	10	[F]

Finishes



BC
Brushed Chrome



BNBDL
Brushed Pewter



DBAC
Brushed Oil Rubbed Bronze



MB
Matte Black



PC
Polished Chrome



SN
Satin Nickel



Shown in Brushed Chrome



Shown in Brushed Oil Rubbed Bronze

CHARMING

Charming and welcoming, Aiden offers a comfortable grip and ample hand clearance with its flowing arch profile. With its coordinating knob and extended sizes, this collection is a favorable choice for universal design needs.

Design Idea

For mudrooms, closets and bathrooms, pair cabinet knobs and pulls with Elements decorative hooks in the same finish for a cohesive look with added organization.



Knobs	Description	Overall Length	Foot		Inner Box	Price Code
			Width x Length	Projection		
993	T-knob	1-5/8"	1/2" x 1/2"	1-1/16"	30	[B]

Pulls	Center-to-Center	Overall Length	Foot		Inner Box	Price Code
			Width x Length	Projection		
993-3	3" CC	4-1/16"	3/8" x 11/16"	1-1/4"	25	[D]
993-96	96 mm (3-3/4") CC	4-3/4"	3/8" x 11/16"	1-1/4"	20	[D]
993-128	128 mm (5-1/16") CC	6-1/8"	7/16" x 11/16"	1-1/4"	15	[E]

Finishes



BNBDL
Brushed Pewter



DBAC
Brushed Oil
Rubbed Bronze



PC
Polished Chrome



SN
Satin Nickel



Pulls	Center-to-Center	Overall Length	Foot Width x Length	Projection	Inner Box	Price Code
308-128	128 mm (5-1/16") CC	5-9/16"	3/8" x 9/16"	15/16"	25	[D]
406-128	128 mm (5-1/16") CC	6-9/16"	5/16" x 5/16"	1-1/4"	20	[E]
745-128	128 mm (5-1/16") CC	5-11/16"	5/8" x 5/8"	1-3/16"	20	[D]
776-128	128 mm (5-1/16") CC	5-11/16"	5/8" x 1/2"	1-3/16"	20	[E]
976-128	128 mm (5-1/16") CC	6-3/16"	1-3/16" x 11/16"	1-1/16"	20	[E]

Finishes



BLK
Matte Black



DN
Dull Nickel



PC
Polished Chrome



SN
Satin Nickel



Knobs	Description	Overall Length	Foot Width x Length	Projection	Inner Box	Price Code
239	round knob	1"	3/8" x 5/8"	1"	30	[B]

Pulls	Center-to-Center	Overall Length	Foot Width x Length	Projection	Inner Box	Price Code
239-96	96 mm (3-3/4") CC	4-5/16"	1/2" x 1/2"	1-1/8"	15	[D]
239-128	128 mm (5-1/16") CC	5-9/16"	1/2" x 1/2"	1-1/8"	15	[E]
239-160	160 mm (6-5/16") CC	6-13/16"	1/2" x 1/2"	1-1/8"	15	[F]
239-192	192 mm (7-9/16") CC	8-1/16"	1/2" x 1/2"	1-1/8"	10	[F]

Finishes



BC
Brushed
Chrome



BNBDL
Brushed
Pewter



DACM
Gun Metal



DBAC
Brushed Oil
Rubbed Bronze



MB
Matte Black



PC
Polished
Chrome



SN
Satin Nickel

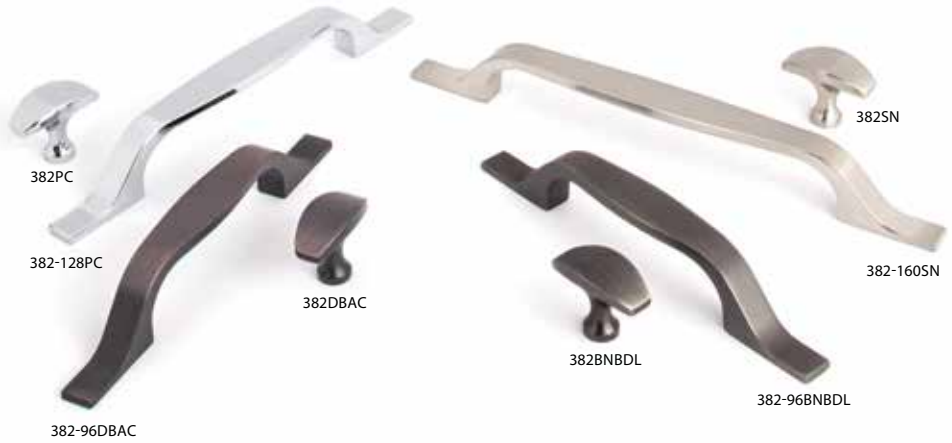

Knobs	Description	Overall Length	Foot Width x Length	Projection	Inner Box	Price Code
382	T-knob	1-1/2"	1/2" x 1/2"	1-1/8"	25	[B]

Pulls	Center-to-Center	Overall Length	Foot Width x Length	Projection	Inner Box	Price Code
382-96	96 mm (3-3/4") CC	6-1/2"	1/2" x 1-1/2"	1-1/16"	15	[E]
382-128	128 mm (5-1/16") CC	7-3/4"	1/2" x 1-1/2"	1-1/16"	10	[F]
382-160	160 mm (6-5/16") CC	9"	1/2" x 1-1/2"	1-1/16"	10	[F]

Finishes



BNBDL
Brushed Pewter



DBAC
Brushed Oil
Rubbed Bronze



PC
Polished Chrome



SN
Satin Nickel



Knobs	Description	Overall Length	Foot Width x Length	Projection	Inner Box	Price Code
2980	round knob	1-1/4"	1" x 1"	1-1/8"	20	[C]
Pulls	Center-to-Center	Overall Length	Foot Width x Length	Projection	Inner Box	Price Code
2981	3" CC cup pull	3-11/16"	1-5/16" x 3-11/16"	1-1/8"	20	[D]

Finishes



AB
Brushed
Antique Brass



BNDL
Brushed Pewter



DACM
Gun Metal



DBAC
Brushed Oil
Rubbed Bronze



MB
Matte Black



ORB
Dark Bronze



PC
Polished Chrome



SBZ
Satin Bronze



SN
Satin Nickel



Shown in Matte Black

SLIM

Instantly upgrade kitchens with this slim and sleek collection of tab pulls from Elements. Edgefield features a thin design that is the ideal choice for contemporary homes.

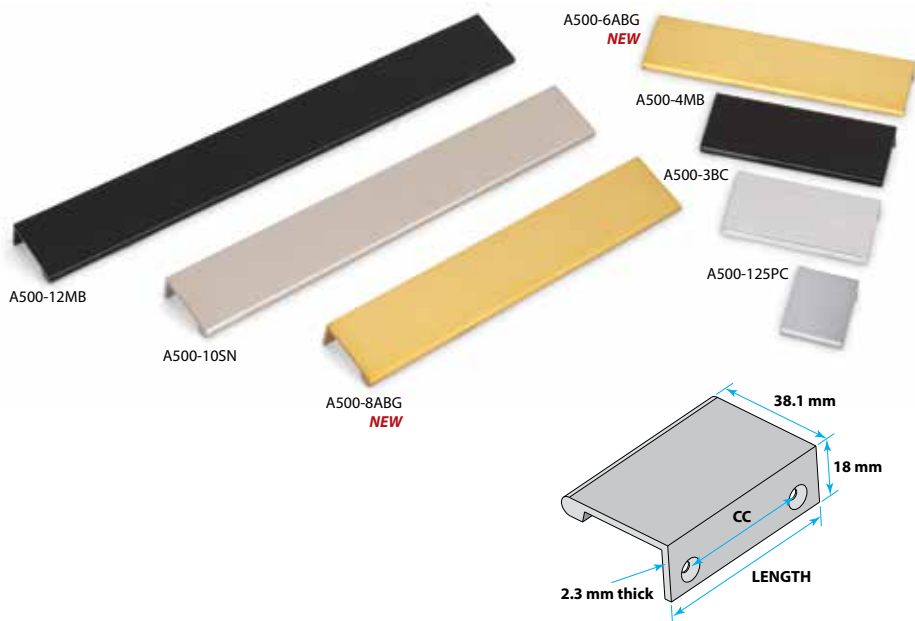

Pulls	Center-to-Center	Overall Length	Foot Width x Length	Projection	Inner Box	Price Code
A500-125*	16 mm (5/8") CC tab pull	1-1/4"	23/32" x 1-1/4"	1-1/2"	50	[B]
A500-3*	60 mm (2-3/8") CC tab pull	3"	23/32" x 3"	1-1/2"	25	[D]
A500-4*	76 mm (3") CC tab pull	4"	23/32" x 4"	1-1/2"	25	[D]
A500-6*	127 mm (5") CC tab pull	6"	23/32" x 6"	1-1/2"	20	[E]
A500-8*	90 mm (3-9/16") CC tab pull (3 holes)	8"	23/32" x 8"	1-1/2"	20	[F]
A500-10*	114 mm (4-1/2") CC tab pull (3 holes)	10"	23/32" x 10"	1-1/2"	10	[G]
A500-12*	90 mm (3-9/16") CC tab pull (4 holes)	12"	23/32" x 12"	1-1/2"	10	[H]

*Wood screws included with all tab pulls

Finishes



ABG
Aluminum
Brushed Gold
NEW



BC
Brushed Chrome



MB
Matte Black



PC
Polished Chrome



SN
Satin Nickel

Gibson

New sizes and knob

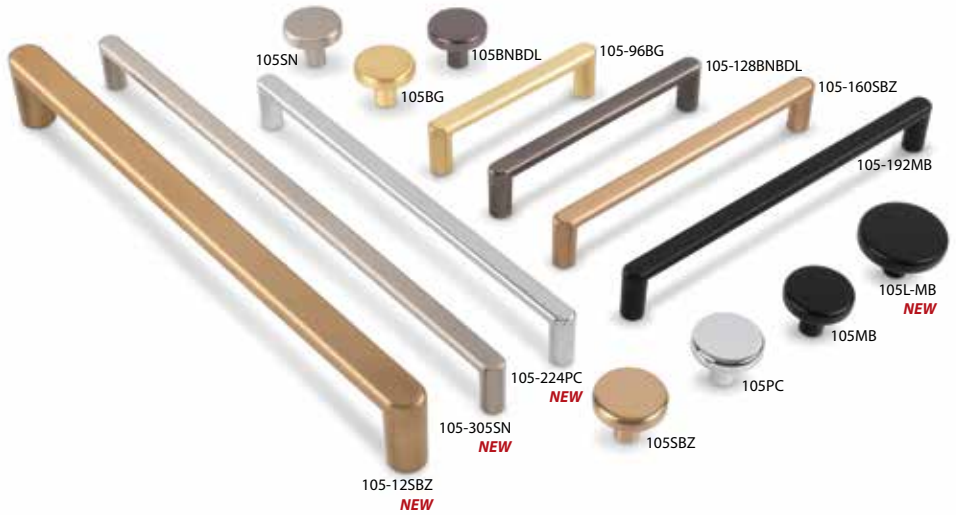

Knobs	Description	Overall Length	Foot Width x Length	Projection	Inner Box	Price Code
105	small knob	1-1/4"	7/16" x 7/16"	1"	10	[C]
105L NEW	large knob	1-5/8"	7/16" x 7/16"	1"	10	[E]

Pulls	Center-to-Center	Overall Length	Foot Width x Length	Projection	Inner Box	Price Code
105-96	96 mm (3-3/4") CC	4-1/4"	7/16" x 7/16"	1-1/8"	10	[D]
105-128	128 mm (5-1/16") CC	5-1/2"	7/16" x 7/16"	1-1/8"	10	[D]
105-160	160 mm (6-5/16") CC	6-3/4"	7/16" x 7/16"	1-1/8"	10	[E]
105-192	192 mm (7-9/16") CC	8"	7/16" x 7/16"	1-1/8"	10	[F]
105-224 NEW	224 mm (8-13/16")	9-5/16"	7/16" x 7/16"	1-1/8"	10	[G]
105-305 NEW	305 mm (12") CC	12-1/2"	7/16" x 7/16"	1-1/8"	10	[K]
105-12 NEW	12" CC appl. handle	12-3/4"	3/4" x 3/4"	1-1/8"	1	[K]

Finishes



BG
Brushed Gold



BNBDL
Brushed Pewter



MB
Matte Black



PC
Polished Chrome



SBZ
Satin Bronze



SN
Satin Nickel



Shown in Brushed Pewter

HARMONIC

Gibson, with its clean, casual lines, brings an effortless, harmonic vibe to any contemporary or transitional space. A coordinating smooth and simplistic 1-1/4" diameter cabinet knob pairs melodiously with its cabinet pull. The standard pull features soft outer curves and straight lines that flow into cylindrical feet producing an easy-going feel. This closed-end bar pull collection is a crowd-pleaser.



Shown in Matte Black

FUN

Hadly has quickly flourished into a crowd favorite with its fun and lively square silhouette. The clean lines, softened curves, strikingly sculpted flared feet, and variety of lengths and finishes of this knob and pull combination blend seamlessly with contemporary or transitional spaces.

Design Idea

Black and gold accents add so much personality to a predominantly white space. Don't be afraid to pair matte black hardware with gold accents to add pizzazz to any kitchen or bath.

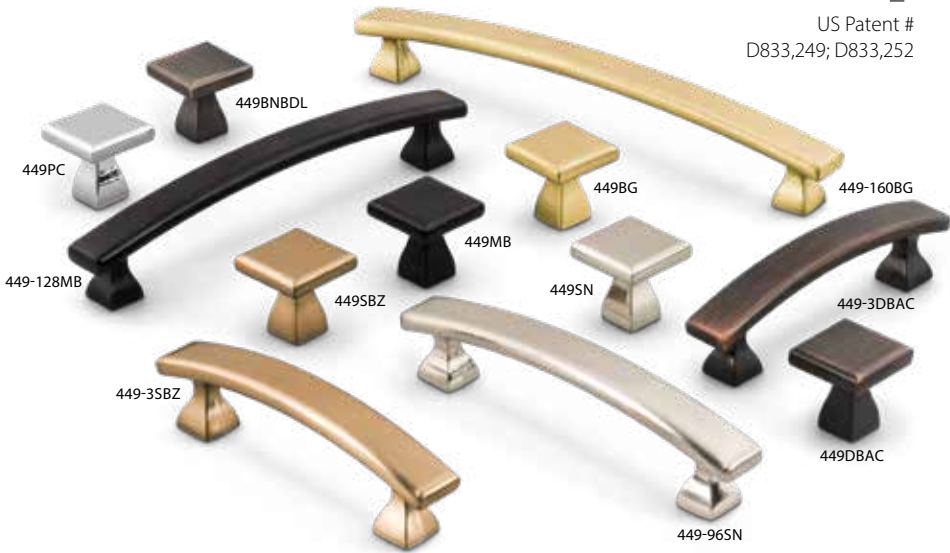

Knobs	Description	Overall Length	Foot Width x Length	Projection	Inner Box	Price Code
449	square knob	1"	1/2" x 1/2"	1"	25	[C]

Pulls	Center-to-Center	Overall Length	Foot Width x Length	Projection	Inner Box	Price Code
449-3	3" CC	4"	1/2" x 1/2"	1-1/8"	15	[D]
449-96	96 mm (3-3/4") CC	4-3/4"	1/2" x 1/2"	1-1/8"	15	[D]
449-128	128 mm (5-1/16") CC	6"	1/2" x 1/2"	1-1/8"	10	[E]
449-160	160 mm (6-5/16") CC	7-1/4"	1/2" x 1/2"	1-1/8"	10	[F]

Finishes



BG
Brushed Gold



BNBDL
Brushed Pewter



DBAC
Brushed Oil
Rubbed Bronze



MB
Matte Black



PC
Polished Chrome



SBZ
Satin Bronze



SN
Satin Nickel



Knobs	Description	Overall Length	Foot Width x Length	Projection	Inner Box	Price Code
525	square knob	1-1/8"	1/4" x 1/4"	15/16"	50	[C]
Pulls	Center-to-Center	Overall Length	Foot Width x Length	Projection	Inner Box	Price Code
525-96	96 mm (3-3/4") CC	4-15/16"	15/16" x 13/16"	15/16"	25	[D]

Finishes





Knobs	Description	Overall Length	Foot Width x Length	Projection	Inner Box	Price Code
3970	round knob	1-1/4"	3/4" x 3/4"	1-1/16"	25	[A]

Pulls	Center-to-Center	Overall Length	Foot Width x Length	Projection	Inner Box	Price Code
254-3	3" CC	5"	11/16" x 1-1/8"	15/16"	20	[B]
254-96	96 mm (3-3/4") CC	5-3/4"	11/16" x 1-1/8"	15/16"	20	[D]

Finishes





Pulls	Center-to-Center	Overall Length	Foot Width x Length	Projection	Inner Box	Price Code
645-96	96 mm (3-3/4") CC	4-1/4"	5/16" x 15/16"	1-3/8"	10	[E]
645-128	128 mm (5-1/16") CC	5-9/16"	5/16" x 15/16"	1-3/8"	10	[F]
645-160	160 mm (6-5/16")	6-13/16"	5/16" x 15/16"	1-3/8"	10	[F]
645-192	192 mm (7-9/16")	8-1/16"	5/16" x 15/16"	1-3/8"	10	[G]
645-224	224 mm (8-13/16")	9-5/16"	5/16" x 15/16"	1-3/8"	10	[G]
645-320	320 mm (12-5/8") CC	13-1/16"	5/16" x 15/16"	1-3/8"	10	[H]

Finishes



MB
Matte Black



PC
Polished Chrome



SN
Satin Nickel



Shown in Matte Black

SUBTLE

A subtle reflection of a warded lock key, Knox pairs leading lines and intentional curves for a simple yet distinctive look. This closed-ended bar pull series offers a generous 1" hand clearance for an aesthetically pleasing option for aging in place and ADA projects.

Design Idea

When choosing hardware, think about how often the drawers or doors are used, as well as who the user is. Longer pulls and pulls with a larger hand clearance are easier to grab, especially for users with limited hand mobility.



Knobs	Description	Overall Length	Foot Width x Length	Projection	Inner Box	Price Code
3910	round knob	1-3/16"	11/16" x 11/16"	1-1/8"	30	[B]
Pulls	Center-to-Center	Overall Length	Foot Width x Length	Projection	Inner Box	Price Code
Z259-3	3" CC	3-3/8"	3/8" x 3/8"	1-1/8"	50	[B]

Finishes



AB Brushed Antique Brass
BC Brushed Chrome
BG Brushed Gold
BN Black Nickel
BNBDL Brushed Pewter
DACM Gun Metal
DBAC Brushed Oil Rubbed Bronze



MB Matte Black
ORB Dark Bronze
PB Polished Brass
PC Polished Chrome
SB Satin Brass
SBZ Satin Bronze
SN Satin Nickel



Knobs	Description	Overall Length	Foot Width x Length	Projection	Inner Box	Price Code
183	square knob	1"	3/8" x 1/2"	1-1/8"	25	[C]

Pulls	Center-to-Center	Overall Length	Foot Width x Length	Projection	Inner Box	Price Code
183-3	3" CC	3-3/4"	5/16" x 1/2"	1-1/8"	15	[D]
183-96	96 mm (3-3/4") CC	4-1/2"	5/16" x 1/2"	1-1/8"	15	[D]

Finishes





EVERLASTING

This cylindrical and classic bar pull from Naples is an everlasting design, perfect for a variety of cabinet styles. Use this straight-line bar pull collection from Elements to seamlessly update cabinets and furniture, bringing a modern look to any room. Available in solid steel as well as hollow stainless steel, in a variety of lengths and finishes.



Shown in Matte Black

Naples

Design Idea

Coordinate knobs and pulls with other elements in the kitchen like faucets, door hardware, and lighting to create a cohesive look.



Shown in Brushed Gold





Knobs	Description	Overall Length	Foot Width x Length	Projection	Inner Box	Price Code
40	T-knob	1-9/16"	3/8" x 3/8"	1-3/8"	30	[B]

Pulls	Center-to-Center	Overall Length	Foot Width x Length	Projection	Inner Box	Price Code
136	3" CC	5-3/8"	3/8" x 3/8"	1-3/8"	10	[C]
156	96 mm (3-3/4") CC	6-1/8"	3/8" x 3/8"	1-3/8"	10	[D]
176	128 mm (5-1/16") CC	6-15/16"	3/8" x 3/8"	1-3/8"	10	[D]
206	128 mm (5-1/16") CC	8-1/8"	3/8" x 3/8"	1-3/8"	10	[E]
220	160 mm (6-5/16") CC	8-11/16"	3/8" x 3/8"	1-3/8"	10	[E]
272	192 mm (7-9/16") CC	10-11/16"	3/8" x 3/8"	1-3/8"	10	[E]
304	224 mm (8-13/16") CC	11-15/16"	3/8" x 3/8"	1-3/8"	10	[F]
336	256 mm (10-1/16") CC	13-1/4"	3/8" x 3/8"	1-3/8"	10	[F]
368	288 mm (11-5/16") CC	14-1/2"	3/8" x 3/8"	1-3/8"	10	[F]
399	319 mm (12-9/16") CC	15-11/16"	3/8" x 3/8"	1-3/8"	10	[G]
496	416 mm (16-3/8") CC	19-1/2"	3/8" x 3/8"	1-3/8"	10	[G]
560*	480 mm (18-7/8") CC	22-1/16"	3/8" x 3/8"	1-3/8"	10	[H]
624*	544 mm (21-7/16") CC	24-9/16"	3/8" x 3/8"	1-3/8"	10	[H]
720*	640 mm (25-3/16") CC	28-3/8"	3/8" x 3/8"	1-3/8"	10	[J]
763*	673 mm (26-1/2") CC	30-1/16"	3/8" x 3/8"	1-3/8"	10	[J]

*Available only in Polished Chrome and Satin Nickel

Finishes



BG



DBB



MB



PC



SBZ



SN

Brushed Gold Dark Brushed Bronze Matte Black Polished Chrome Satin Bronze Satin Nickel
(up to 416 mm CC) (up to 416 mm CC) (up to 416 mm CC) (all lengths) (up to 416 mm CC) (all lengths)

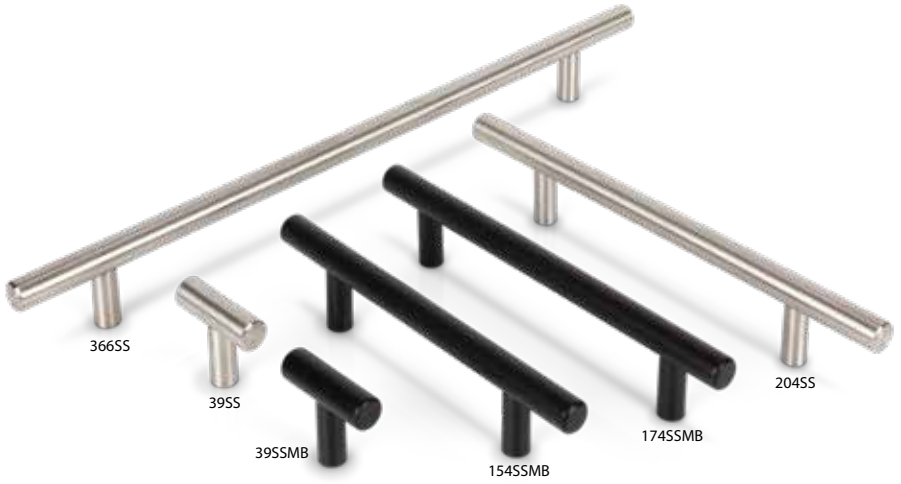

Knobs	Description	Overall Length	Foot Width x Length	Projection	Inner Box	Price Code
39	T-knob	1-9/16"	3/8" x 3/8"	1-3/8"	40	[A]

Pulls	Center-to-Center	Overall Length	Foot Width x Length	Projection	Inner Box	Price Code
154	96 mm (3-3/4") CC	6-1/16"	3/8" x 3/8"	1-3/8"	20	[C]
174	128 mm (5-1/16") CC	6-7/8"	3/8" x 3/8"	1-3/8"	20	[D]
204	128 mm (5-1/16") CC	8-1/16"	3/8" x 3/8"	1-3/8"	20	[E]
218S	160 mm (6-5/16") CC	8-9/16"	3/8" x 3/8"	1-3/8"	20	[E]
270	192 mm (7-9/16") CC	10-5/8"	3/8" x 3/8"	1-3/8"	20	[E]
302	224 mm (8-13/16") CC	11-7/8"	3/8" x 3/8"	1-3/8"	20	[E]
334	256 mm (10-1/16") CC	13-1/8"	3/8" x 3/8"	1-3/8"	20	[F]
366	288 mm (11-5/16") CC	14-7/16"	3/8" x 3/8"	1-3/8"	10	[F]
397	319 mm (12-9/16") CC	15-5/8"	3/8" x 3/8"	1-3/8"	10	[F]
494	416 mm (16-3/8") CC	19-7/16"	3/8" x 3/8"	1-3/8"	10	[G]
558	480 mm (18-7/8") CC	21-15/16"	3/8" x 3/8"	1-3/8"	10	[G]
622	544 mm (21-7/16") CC	24-1/2"	3/8" x 3/8"	1-3/8"	10	[H]
719	640 mm (25-3/16") CC	28-5/16"	3/8" x 3/8"	1-3/8"	10	[H]
761	673 mm (26-1/2") CC	29-15/16"	3/8" x 3/8"	1-3/8"	10	[H]

Finishes



SS
Stainless Steel



SSMB
Matte Black
Stainless Steel



Knobs	Description	Overall Length	Foot Width x Length	Projection	Inner Box	Price Code
511	round knob	1-1/4"	3/8" x 3/8"	1-1/8"	25	[B]

Pulls	Center-to-Center	Overall Length	Foot Width x Length	Projection	Inner Box	Price Code
511-3	3" CC	4-1/16"	5/8" x 11/16"	1-1/8"	15	[D]
511-96	96 mm (3-3/4") CC	4-7/8"	5/8" x 11/16"	1-1/8"	15	[D]

Finishes



BNBDL
Brushed Pewter



DBAC
Brushed Oil
Rubbed Bronze



PC
Polished Chrome



SN
Satin Nickel



Shown in Brushed Oil Rubbed Bronze



Knobs	Description	Overall Length	Foot Width x Length	Projection	Inner Box	Price Code
26	round knob	1"	3/8" x 3/8"	15/16"	30	[B]

Pulls	Center-to-Center	Overall Length	Foot Width x Length	Projection	Inner Box	Price Code
400	3" CC	4"	5/16" x 5/16"	1-1/4"	10	[D]
475	96 mm (3-3/4") CC	4-3/4"	5/16" x 5/16"	1-1/4"	10	[E]
600	128 mm (5-1/16") CC	6"	5/16" x 5/16"	1-1/4"	10	[F]

Finishes



MB
Matte Black



SBZ
Satin Bronze



SN
Satin Nickel





Knobs	Description	Overall Length	Foot Width x Length	Projection	Inner Box	Price Code
3915	round knob	1"	11/16" x 11/16"	15/16"	50	[A]

Pulls	Center-to-Center	Overall Length	Foot Width x Length	Projection	Inner Box	Price Code
984-3	3" CC	3-5/16"	5/16" x 5/16"	7/8"	30	[C]
984-96	96 mm (3-3/4") CC	4-1/8"	5/16" x 5/16"	7/8"	25	[C]
984-128	128 mm (5-1/16") CC	5-5/16"	5/16" x 5/16"	7/8"	25	[D]
984-160	160 mm (6-5/16") CC	6-11/16"	5/16" x 5/16"	7/8"	15	[D]
984-192	192 mm (7-9/16") CC	7-7/8"	5/16" x 5/16"	7/8"	15	[E]

Finishes



BNBDL
Brushed
Pewter



DACM
Gun Metal



DBAC
Brushed Oil
Rubbed Bronze



PC
Polished
Chrome



SN
Satin Nickel



Shown in Satin Nickel



Pulls	Center-to-Center	Overall Length	Foot Width x Length	Projection	Inner Box	Price Code
8004	96 mm (3-3/4") CC	4-15/16"	3/8" x 3/4"	1-1/16"	30	[C]
81065	128 mm (5-1/16") CC	6-1/8"	7/16" x 11/16"	1-1/8"	25	[D]
80814	96 mm (3-3/4") CC	5"	1/2" x 13/16"	7/8"	30	[B]
80815	128 mm (5-1/16") CC	6-5/16"	9/16" x 7/8"	1-1/8"	25	[D]

Finishes



BNBDL
Brushed Pewter



DBAC
Brushed Oil
Rubbed Bronze



MB
Matte Black



PC
Polished Chrome



SBZ
Satin Bronze



SN
Satin Nickel



Shown in Brushed Gold

CONFIDENT

Sleek, clean, and confident, Stanton is a perfect alternative to the traditional rounded bar pull look. With extended lengths and six finishes to choose from, this pull series flawlessly suits all cabinet styles.



Pulls	Center-to-Center	Overall Length	Foot Width x Length	Projection	Inner Box	Price Code
625-3	3" CC	3-3/8"	3/8" x 3/8"	1-1/8"	20	[D]
625-96	96 mm (3-3/4") CC	4-1/8"	3/8" x 3/8"	1-1/8"	25	[E]
625-128	128 mm (5-1/16") CC	5-3/8"	3/8" x 3/8"	1-1/8"	20	[E]
625-160	160 mm (6-5/16") CC	6-5/8"	3/8" x 3/8"	1-1/8"	10	[F]
625-192	192 mm (7-9/16") CC	7-15/16"	3/8" x 3/8"	1-1/8"	10	[F]
625-224	224 mm (8-13/16") CC	9-3/16"	3/8" x 3/8"	1-1/8"	10	[G]
625-320	320 mm (12-5/8") CC	12-15/16"	3/8" x 3/8"	1-1/8"	10	[H]
625-448	448 mm (17-5/8") CC	18"	3/8" x 3/8"	1-1/8"	10	[J]

Finishes



BG
Brushed Gold



MB
Matte Black



MS
Matte Silver



PC
Polished Chrome



SBZ
Satin Bronze



SN
Satin Nickel



Pulls	Center-to-Center	Overall Length	Foot Width x Length	Projection	Inner Box	Price Code
771-3	3" CC	4-1/2"	5/8" x 13/16"	15/16"	20	[D]
771-96	96 mm (3-3/4") CC	5-3/16"	5/8" x 1-1/8"	15/16"	20	[D]
771-128	128 mm (5-1/16") CC	6-5/16"	5/8" x 1-1/8"	1"	20	[E]
771-160	160 mm (6-5/16") CC	7-11/16"	5/8" x 1-3/16"	1-1/16"	20	[F]

Finishes



BNBDL
Brushed Pewter



DBAC
Brushed Oil
Rubbed Bronze



PC
Polished Chrome



SN
Satin Nickel



Shown in Satin Nickel



Aluminum Pulls	Center-to-Center	Overall Length	Foot Width x Length	Foot Projection	Inner Box	Price Code
A271-3AL	3" CC	3-5/16"	5/16" x 5/16"	1-1/4"	30	[A]
A271-3.5AL	3-1/2" CC	3-13/16"	5/16" x 5/16"	1-1/4"	30	[A]
A271-96AL	96 mm (3-3/4") CC	4-1/16"	5/16" x 5/16"	1-1/4"	30	[A]
A271-4AL	4" CC	4-5/16"	5/16" x 5/16"	1-1/4"	30	[A]

Stainless Steel Pulls	Center-to-Center	Overall Length	Foot Width x Length	Foot Projection	Inner Box	Price Code
K271-3SS	3" CC	3-5/16"	5/16" x 5/16"	1-1/4"	30	[D]
K271-3.5-SS	3-1/2" CC	3-13/16"	5/16" x 5/16"	1-1/4"	30	[C]
K271-96-SS	96 mm (3-3/4") CC	4-1/16"	5/16" x 5/16"	1-1/4"	30	[C]
K271-4SS	4" CC	4-5/16"	5/16" x 5/16"	1-1/4"	30	[D]

Steel Pulls	Center-to-Center	Overall Length	Foot Width x Length	Foot Projection	Inner Box	Price Code
S271-3	3" CC	3-5/16"	5/16" x 5/16"	1-1/4"	30	[A]
S271-3.5	3-1/2" CC	3-13/16"	5/16" x 5/16"	1-1/4"	30	[A]
S271-96	96 mm (3-3/4") CC	4-1/16"	5/16" x 5/16"	1-1/4"	30	[A]
S271-4	4" CC	4-5/16"	5/16" x 5/16"	1-1/4"	30	[A]
S271-128	128 mm (5-1/16") CC	5-5/16"	5/16" x 5/16"	1-1/4"	20	[A]

Finishes



AL Aluminum	BC Brushed Chrome	DBAC Brushed Oil Rubbed Bronze	MB Matte Black	PB Polished Brass	PC Polished Chrome	SN Satin Nickel	SS Stainless Steel
-----------------------	-----------------------------	--	--------------------------	-----------------------------	------------------------------	---------------------------	------------------------------

Thatcher



Knobs	Description	Overall Length	Foot Width x Length	Projection	Inner Box	Price Code
859T	T-knob	1-7/16"	5/16" x 7/16"	1-1/16"	25	[B]

Pulls	Center-to-Center	Overall Length	Foot Width x Length	Projection	Inner Box	Price Code
859-3	3" CC	5-5/16"	5/16" x 7/16"	1-1/16"	25	[C]
859-96	96 mm (3-3/4") CC	6-1/8"	5/16" x 7/16"	1-1/8"	25	[C]
859-128	128 mm (5-1/16") CC	7-1/2"	5/16" x 7/16"	1-1/8"	25	[D]
859-160	160 mm (6-5/16") CC	8-9/16"	5/16" x 7/16"	1-3/16"	25	[E]

Finishes



BG
Brushed Gold



BNBDL
Brushed Pewter



DBAC
Brushed Oil
Rubbed Bronze



MB
Matte Black



PC
Polished Chrome



SBZ
Satin Bronze



SN
Satin Nickel



Shown in Brushed Gold

CASUAL

A slightly round strap sitting atop the rounded feet of Thatcher creates a casual, easy-going vibe. A matching T-knob combined with extended lengths and top trending finishes make this collection the perfect match for any style of cabinets.

Design Idea

For kitchens with two-tone cabinets, using the same hardware throughout is a reliable choice that ties everything together flawlessly.



Shown in Matte Black

STRIKING

Simplistic yet striking, Walker adds a balanced look to any space with long, clean lines and a comfortable, ergonomic grip. This collection stands apart from others by offering four standard pull lengths in two widths, ½" and ¾", to satisfy all design aesthetics.

Finishes



BG
Brushed
Gold



BNBDL
Brushed
Pewter



MB
Matte
Black



PC
Polished
Chrome



SBZ
Satin
Bronze



SN
Satin
Nickel

Walker 1 & 2



Walker 1

Knobs	Description	Overall Length	Foot Width x Length	Projection	Inner Box	Price Code
827	square knob	1-1/4"	3/8" x 3/8"	1-1/8"	25	[D]
827L	large square knob	1-5/8"	1/2" x 1/2"	1-1/4"	10	[D]
Pulls (3/4" width)	Center-to-Center	Overall Length	Foot Width x Length	Projection	Inner Box	Price Code
827-96	96 mm (3-3/4") CC	4-1/8"	3/4" x 3/8"	1-1/4"	10	[E]
827-128	128 mm (5-1/16") CC	5-3/8"	3/4" x 3/8"	1-1/4"	10	[F]
827-160	160 mm (6-5/16") CC	6-11/16"	3/4" x 3/8"	1-1/4"	10	[F]
827-192	192 mm (7-9/16") CC	7-15/16"	3/4" x 3/8"	1-1/4"	10	[G]
827-12	12" CC appl. handle	12-1/2"	1-1/8" x 1/2"	1-3/4"	5	[K]

Walker 2

Pulls (1/2" width)	Center-to-Center	Overall Length	Foot Width x Length	Projection	Inner Box	Price Code
727-96	96 mm (3-3/4") CC	4"	1/2" x 1/4"	1-1/8"	25	[D]
727-128	128 mm (5-1/16") CC	5-5/16"	1/2" x 1/4"	1-1/8"	15	[D]
727-160	160 mm (6-5/16") CC	6-9/16"	1/2" x 1/4"	1-1/8"	15	[E]
727-192	192 mm (7-9/16") CC	7-13/16"	1/2" x 1/4"	1-1/8"	15	[E]

William

New collection



Knobs	Description	Overall Length	Foot Width x Length	Projection	Inner Box	Price Code
641	square knob	1-1/4"	5/16" x 9/16"	1-3/16"	25	[C]

Pulls	Center-to-Center	Overall Length	Foot Width x Length	Projection	Inner Box	Price Code
641-3	3" CC	4-1/4"	1/4" x 7/16"	1-1/8"	20	[D]
641-96	96 mm (3-3/4") CC	5"	1/4" x 7/16"	1-1/8"	15	[D]
641-128	128 mm (5-1/16") CC	6-1/4"	1/4" x 7/16"	1-1/8"	15	[E]
641-160	160 mm (6-5/16") CC	7-1/2"	1/4" x 7/16"	1-1/8"	10	[F]

Finishes



BG
Brushed
Gold

BNBDL
Brushed
Pewter

DBAC
Brushed Oil
Rubbed Bronze

MB
Matte
Black

PC
Polished
Chrome

SBZ
Satin
Bronze

SN
Satin
Nickel

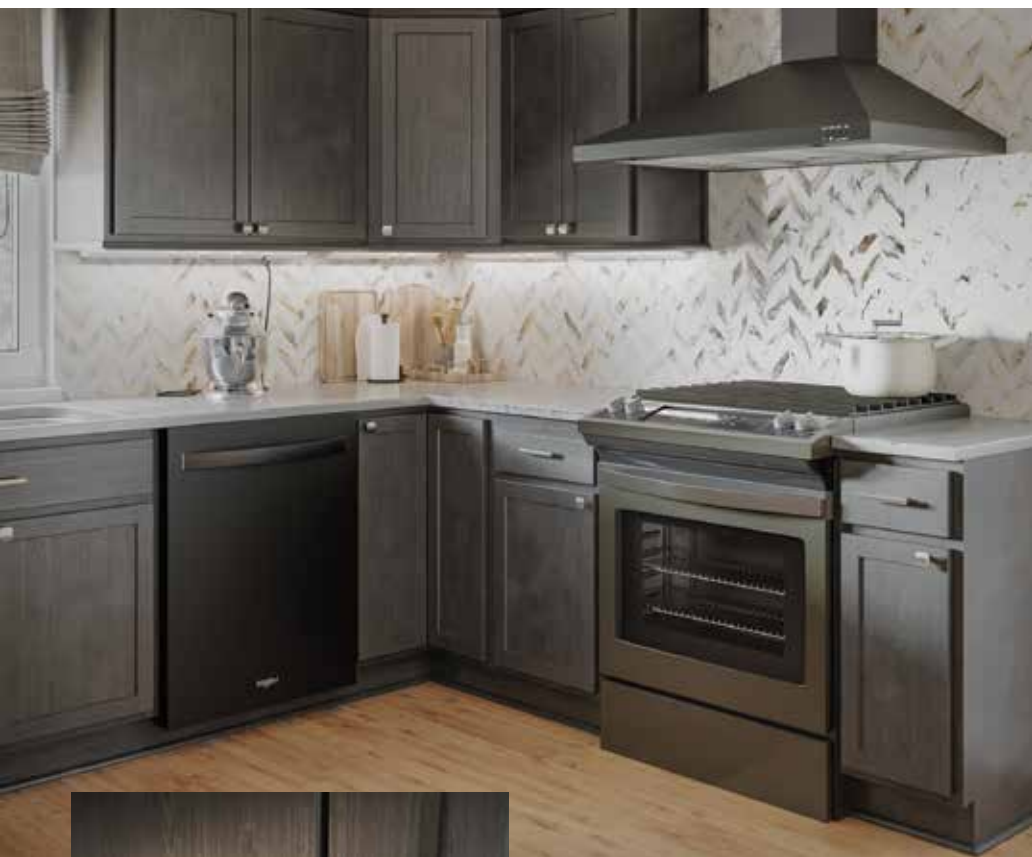

Shown in Satin Nickel

SCULPTED

William embodies bold modernistic design, captivating all with its intricately sculpted yet soft geometric form. It offers four pull lengths and a coordinating knob in seven stunning finishes. The collection's angular facets effortlessly infuse a subtle hint of contemporary flair to any cabinet or furniture piece it adorns. Embracing the core of the modernist spirit, William creates an ambiance beyond the ordinary.



Knobs	Description	Overall Length	Foot		Inner Box	Price Code
			Width x Length	Projection		
647	round knob	1-1/8"	5/8" x 5/8"	15/16"	20	[A]

Pulls	Center-to-Center	Overall Length	Foot		Inner Box	Price Code
			Width x Length	Projection		
647-3	3" CC	4-5/8"	7/8" x 15/16"	1"	15	[B]
647-96	96 mm (3-3/4") CC	5-3/8"	7/8" x 15/16"	1"	20	[D]

Finishes



BNBDL

Brushed Pewter



DBAC

Brushed Oil
Rubbed Bronze



PC

Polished Chrome



SN

Satin Nickel



Shown in Brushed Oil Rubbed Bronze



Knobs	Description	Overall Length	Foot Width x Length	Projection	Inner Box	Price Code
988	round knob	1-1/16"	7/16" x 7/16"	1"	25	[A]
Pulls	Center-to-Center	Overall Length	Foot Width x Length	Projection	Inner Box	Price Code
988-3	3" CC	3-3/4"	5/16" x 9/16"	1-3/16"	20	[B]
988-96	96 mm (3-3/4") CC	4-1/2"	5/16" x 9/16"	1-3/16"	20	[D]
988-128	128 mm (5-1/16") CC	5-13/16"	5/16" x 9/16"	1-1/4"	15	[D]
988-160	160 mm (6-5/16") CC	7-1/16"	5/16" x 9/16"	1-1/4"	10	[E]

Finishes



BNBDL
Brushed Pewter



DBAC
Brushed Oil
Rubbed Bronze



MB
Matte Black



PC
Polished Chrome



SN
Satin Nickel

Cabinet Hardware Selection & Sizing Guide

Need some help choosing hardware for your cabinets?
Although there are no formal rules for hardware selection, there are some guidelines you can follow that can help you select the hardware that best fits your style and budget.

Knobs vs. Pulls

Knobs are smaller on the cabinets and are a suitable choice when you want to highlight the beauty of your cabinets or backsplash. They work best on cabinet doors.

Pulls are larger than knobs and can make a more significant statement than knobs alone. They also make opening doors/drawers easier and are available in multiple sizes to add variety and give your cabinets a more customized designer look.



You could opt for knobs on upper cabinets and pulls on lower cabinets...



...or choose all pulls for a streamlined, modern look

Pull Sizes

Remember, there are no set rules, so choose the length that best complements your cabinets and the level of functionality needed. **Pro Tip:** Selecting a cabinet pull that is at least $\frac{1}{3}$ the length of the door and $\frac{1}{3}$ to $\frac{1}{2}$ the width of the drawer is always a safe choice.



Choosing longer cabinet pulls makes it easier to grip and access your doors and drawers, increasing the functionality of your space while creating a clean and modern, high-end look.

Pull size is $\frac{1}{2}$ the width of the drawer

OR...

Pull size is $\frac{1}{3}$ the width of the drawer

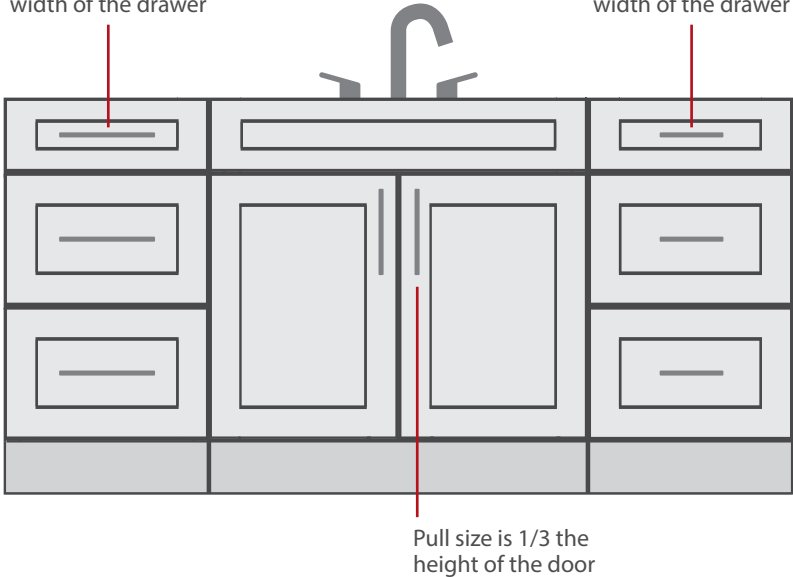

Pull size is $\frac{1}{3}$ the height of the door



To watch a video on the length selection process, scan the QR code or visit <https://delivr.com/28cw8>



Dominique shown in Satin Bronze

Appliance Handles



Richard shown in Satin Nickel



Belcastel 1 shown in Satin Nickel



12" CC or 18" CC Larkin 3 (Knurled Center) Appliance Handle
(full collection on page 43)

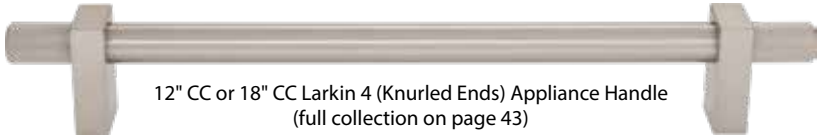

12" CC or 18" CC Larkin 4 (Knurled Ends) Appliance Handle
(full collection on page 43)



12" CC or 18" CC Loxley Appliance Handle
(full collection on page 47)



12" CC or 18" CC Whitlock Appliance Handle
(full collection on page 78)

Collection	12" Center-to-Center	18" Center-to-Center	Finishes Available	See Page
Audrey	✓	✓	BG, BNBDL, DBAC, MB, PC, SBZ, SN	6
Belcastel 1	✓	✓	ABM-D, BNBDL, DACM, DBAC, DMAC, MB, NI, PC, SBZ, SIM-D, SN	9
Bremen 1	✓		ABM-D, ABSB, BNBDL, DACM, DBAC, DMAC, NI, PC, SBZ, SIM, SN	12
Bremen 2	✓		ABSB, DACM, DBAC, DMAC, NI, SN	14
Cordova	✓	✓	ABSB, BNBDL, DBAC, SN	20
Delgado	✓	✓	ABSB, BNBDL, DBAC, NI, SN	21
Delmar	✓		BNBDL, DACM, DBAC, DP, SN	22
Dominique	✓	✓	BG, BNBDL, DBAC, MB, PC, SBZ, SN	24
Durham	✓		ABSB, BNBDL, DACM, DBAC, MB, ORB, PC, SN	23
Ella	✓		BNBDL, DBAC, NI, PC, SN	28
Hudson	✓		BNBDL, DBAC, PC, SN	32
Lafayette	✓		ABSB, BNBDL, DBAC, SN	38
Larkin 1	✓	✓	BG, MB, PC, SBZ, SN	42
Larkin 2	✓	✓	MBSB, MBPC, MBSBZ, MBSN	42
Larkin 3 NEW	✓	✓	BG, MB, SBZ, SN	43
Larkin 4 NEW	✓	✓	BG, MB, SBZ, SN	43
Loxley NEW	✓	✓	BG, BNBDL, DBAC, MB, PC, SBZ, SN	47
Marie	✓	✓	BNBDL, DBAC, MB, PC, SBZ, SN	48
Marlo	✓		BNBDL, DBAC, NI, PC, SN	49
Milan 1	✓		AB, AEM, BNBDL, DACM, DBAC, MB, PC, SN	52
Richard	✓	✓	BG, BNBDL, DBAC, MB, PC, SBZ, SN	60
Roman	✓		BG, BNBDL, DBAC, MB, NI, PC, SBZ, SN	63
Tahoe	✓		BLK, DMAC, SIM	76
Tiffany	✓		BG, BNBDL, DBAC, NI, PC, SBZ, SN	74
Wheeler		✓	BG, BNBDL, DBAC, MB, PC, SBZ, SN	77
Whitlock NEW	✓	✓	BG, MB, PC, SBZ, SN	78
Gibson	✓		BG, BNBDL, MB, PC, SBZ, SN	92
Walker 1	✓		BG, BNBDL, MB, PC, SBZ, SN	117

JEFFREY ALEXANDER®

by Hardware Resources

Find trending finishes in our most popular collections

Collection	Brushed Gold (BG/ABG/MBBG)	Matte Black (MB/BLK/MBPC/MBSS/MBSN)	Satin Bronze (SBZ/MBSBZ)	See Page
Alvar		✓	✓	3
Annadale		✓		4
Audrey	✓	✓	✓	6
Belcastel 1		✓	✓	9
Boswell		✓		11
Bremen 1			✓	12
Callie		✓	✓	17
Carmen	✓	✓	✓	18
Dominique	✓	✓	✓	24
Durham		✓		23
Elara		✓	✓	27
Hayworth	✓	✓	✓	30
Key Grande	✓	✓		34
Key West & Key Largo	✓	✓	✓	37
Larkin 1 & 2	✓	✓	✓	42
Larkin 3 & 4 <i>NEW</i>	✓	✓	✓	43
Leyton		✓	✓	44
Loxley <i>NEW</i>	✓	✓	✓	47
Marie		✓	✓	48
Merrick		✓	✓	51
Milan 1		✓		52
Mirada		✓		54
Philip	✓	✓	✓	56
Regan		✓		55
Renzo	✓	✓	✓	58
Richard	✓	✓	✓	60
Roman	✓	✓	✓	63
Sonoma		✓		65
Southerland <i>NEW</i>		✓	✓	66
Spencer	✓	✓	✓	69
Sullivan		✓		70
Sutton	✓	✓	✓	73
Tiffany	✓	✓	✓	74
Wheeler	✓	✓	✓	77
Whitlock <i>NEW</i>	✓	✓	✓	78
Zane		✓		81



Find trending finishes in our most popular collections

Collection	Brushed Gold (BG/ABG/MBBG)	Matte Black (MB/BLK/MBSS/MBSN)	Satin Bronze (SBZ/MBSBZ)	See Page
Asher		✓		83
Belfast		✓		86
Brenton		✓		87
Edgefield	✓	✓		91
Florence		✓	✓	89
Gibson	✓	✓	✓	92
Glendale		✓	✓	96
Hadly	✓	✓	✓	95
Kenner		✓		97
Knox		✓		98
Madison	✓	✓	✓	100
Naples	✓	✓	✓	104
Sedona		✓	✓	107
Somerset		✓	✓	109
Stanton	✓	✓	✓	111
Thatcher	✓	✓	✓	114
Torino		✓		113
Walker 1 & 2	✓	✓	✓	117
William <i>NEW</i>	✓	✓	✓	118
Zachary		✓		121

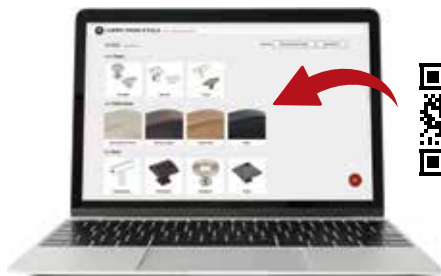

Did you know... you can shop by finish on our website?

To see how, scan the QR code or visit <https://delivr.com/sfjkr>

Item Number Index

ITEM NUMBER	PAGE	ITEM NUMBER	PAGE	ITEM NUMBER	PAGE	ITEM NUMBER	PAGE
26	107	193-128	83	329L	47	519-128	21
39	105	193-160	83	334	105	519-160	21
40	104	204	105	336	104	525	96
48	37	206	104	366	105	525-96	96
51	34	218	38	368	104	527	12
105	92	2185	105	370	37	527-12	12
105-12	92	220	104	382	88	527-128	12
105-96	92	239	87	382-96	88	527-160	12
105-128	92	239-96	87	382-128	88	530	37
105-160	92	239-128	87	382-160	88	537	14
105-192	92	239-160	87	397	105	537-12	14
105-224	92	239-192	87	399	104	537-128	14
105-305	92	242	37	400	107	537-160	14
105L	92	251	20	406-128	86	549-96	51
117	12	254-3	97	417	38	549-128	51
127	14	254-96	97	431	64, 65	549-160	51
136	104	264-3	3	435	4	549-192	51
137	14	264-96	3	435-96	4	549-320	51
141	58	264-128	3	435-128	4	558	105
141-96	58	264-160	3	435-160	4	560	104
141-128	58	264-192	3	435L	4	578-96	69
141-160	58	270	105	436-96	4	578-128	69
141-192	58	272	104	436-128	4	578-160	69
141-305	58	274	37	445	48	578T	69
141L	58	278	6	445-12	48	585	22
146	37	278-12	6	445-18	48	585-12	22
152	37	278-18	6	445-96	48	585-96	22
154	105	278-96	6	445-128	48	585-128	22
156	104	278-128	6	445-160	48	585-160	22
165	28	278-160	6	445-192	48	585L	22
165-12	28	278-192	6	445-224	48	595	15, 64
165-96	28	278-224	6	445-305	48	595-96	15
165-128	28	278-305	6	449	95	595-128	15
165-160	28	278L	6	449-3	95	596	34
171	60	286-96	44	449-96	95	598-12	43
171-12	60	286-128	44	449-128	95	598-18	43
171-18	60	286-160	44	449-160	95	598-96	43
171-96	60	286-192	44	475	107	598-128	43
171-128	60	286-224	44	478-12	42	598-160	43
171-160	60	293-96	81	478-18	42	598-192	43
171-192	60	293-128	81	478-96	42	598-305	43
171-305	60	293-160	81	478-128	42	600	107
171L	60	293-192	81	478-160	42	602	76
174	105	293-224	81	478-192	42	602-12	76
176	104	293-305	81	478-305	42	602-96	76
177-96	11	293T	81	478T	42	602-128	76
177-128	11	302	105	484	27	602S	76
177-160	11	304	104	484-32	27	622	105
177-192	11	308-128	86	484-305	27	624	104
177-224	11	317	38	484-396	27	625-3	111
178	37	317-12	38	484-128160	27	625-96	111
183	101	317-96	38	484-192224	27	625-128	111
183-3	101	317-128	38	494	105	625-160	111
183-96	101	317-160	38	496	104	625-192	111
188	33	329	47	498T	43	625-224	111
188-96	33	329-12	47	511	106	625-320	111
188-128	33	329-18	47	511-3	106	625-448	111
188-160	33	329-96	47	511-96	106	635-32	73
188L	33	329-128	47	519	21	635-96	73
193-3	83	329-160	47	519-12	21	635-128	73
193-4	83	329-192	47	519-18	21	635-160	73
193-96	83	329-305	47	519-96	21	635-256	73

Item Number Index

ITEM NUMBER	PAGE	ITEM NUMBER	PAGE	ITEM NUMBER	PAGE	ITEM NUMBER	PAGE
641	118	767-160	56	905-96	78	8233	39
641-3	118	771-3	112	905-128	78	80152-96	54
641-96	118	771-96	112	905-160	78	80152-128	54
641-128	118	771-128	112	905-192	78	80152-160	54
641-160	118	771-160	112	905-305	78	80814	109
645-96	98	775	18	944	63	80815	109
645-128	98	775-96	18	944-12	63	81021	54
645-160	98	775-128	18	944-96	63	81065	109
645-192	98	775-160	18	944-128	63	A271-3.5AL	113
645-224	98	775L	18	944-160	63	A271-3AL	113
645-320	98	776-128	86	944-192	63	A271-4AL	113
647	120	798-96	64	944-224	63	A271-96AL	113
647-3	120	798-128	64	944-305	63	A500-3	91
647-96	120	798-160	64	950	37	A500-4	91
650	32	827	117	972	49	A500-6	91
650-12	32	827-12	117	972-12	49	A500-8	91
650-96	32	827-96	117	972-96	49	A500-10	91
650-128	32	827-128	117	972-128	49	A500-12	91
650-160	32	827-160	117	972-160	49	A500-125	91
658	74	827-192	117	972-224	49	G110	29
658-12	74	827L	117	972-305	49	G110L	29
658-96	74	839-3	17	972L	49	G120	29
658-128	74	839-96	17	972S	49	G120L	29
658-160	74	839-128	17	976-128	86	G130	29
658-192	74	839-160	17	984-3	108	G130L	29
658-224	74	845	24	984-96	108	G140	29
678	77	845-12	24	984-128	108	G140L	29
678-18	77	845-18	24	984-160	108	G150	29
678-96	77	845-96	24	984-192	108	G150L	29
678-128	77	845-128	24	988	121	K271-3.5-SS	113
678-160	77	845-160	24	988-3	121	K271-3SS	113
686	66	845-192	24	988-96	121	K271-4SS	113
686-96	66	845-305	24	988-128	121	K271-96-SS	113
686-128	66	845T	24	988-160	121	MO6303	9
686-160	66	845TL	24	993	85	MO6373	9
686L	66	847-96	55	993-3	85	MO6373-12	9
698-12	43	847-128	55	993-96	85	MO6373-18	9
698-18	43	847-160	55	993-128	85	MO6373-128	9
698-96	43	859-3	114	1091	52	MO6373-160	9
698-128	43	859-96	114	1092	52	S271-3	113
698-160	43	859-128	114	1092-12	52	S271-3.5	113
698-192	43	859-160	114	1092-128	52	S271-4	113
698-305	43	859T	114	1092-160	52	S271-96	113
719	105	867	5	2980	89	S271-128	113
720	104	867-3	5	2981	89	Z110	20
722	37	867-96	5	3910	100	Z111	20
727-96	117	867-128	5	3915	108	Z259-3	100
727-128	117	867-160	5	3970	97	Z280	20
727-160	117	867-228	5	3980	23	Z281	20
727-192	117	867-320	5	3991	39	Z281-12	20
745-128	86	867L	5	4128	65	Z281-18	20
752-19	70	885	30	4160	65	Z281-128	20
752-96	70	885-96	30	4192	65	Z281-160	20
752-128	70	885-128	30	4288	65	Z290-3	23
752-160	70	885-160	30	5128	34	Z290-12	23
752-192	70	885-192	30	5192	34	Z290-96	23
752-224	70	885-224	30	5224	34	Z290-128	23
761	105	885-305	30	5319	34	Z290-160	23
763	104	885L	30	5480	34		
767	56	905	78	5673	34		
767-96	56	905-12	78	5900	34		
767-128	56	905-18	78	8004	109		

Available Finishes



All brushed, antique, and distressed finishes are created by hand to add texture to the item. We hold a tight range of acceptance for color variation, however, a slight variance in the texture and tone of these items can occur. We consider these variances to be minimal; slight variations are normal.

